

The City of Mississauga, Town of
Caledon, and Region of Peel

Discussion Paper:

**The Effect of Development Related
Costs on Housing Affordability**

April 2019

N. BARRY LYON CONSULTANTS LIMITED
WITH HEMSON CONSULTING LIMITED



HEMSON
Consulting Ltd.

The City of Mississauga, Town of Caledon, and Region of Peel

The Effect of Development Related Costs on Housing Affordability

Table of Contents

Executive Summary	i
1.0 Introduction.....	1
2.0 Background.....	2
3.0 Housing Prices and Costs – The Factors Influencing these Fundamental Inputs of Real Estate Development	14
4.0 Development Case Studies in Peel Region	22
5.0 Discussion Questions and Conclusions.....	41
Appendix A: Case Study Built Form Analysis	50
Appendix B: Market Data	62
Appendix C: Land Transaction Data.....	72
Appendix D: Home Value and Development Charge Data	77
Appendix E: Financial Analysis.....	80

Disclaimer:

The conclusions contained in this report have been prepared based on both primary and secondary data sources. NBLC makes every effort to ensure the data is correct but cannot guarantee its accuracy. It is also important to note that it is not possible to fully document all factors or account for all changes that may occur in the future and influence the viability of any development. NBLC, therefore, assumes no responsibility for losses sustained as a result of implementing any recommendation provided in this report.

This report has been prepared solely for the purposes outlined herein and is not to be relied upon, or used for any other purposes, or by any other party without the prior written authorization from N. Barry Lyon Consultants Limited.

Executive Summary

N. Barry Lyon Consultants Limited (“NBLC”) with Hemson Consulting has been retained by the City of Mississauga, Town of Caledon, and Region of Peel to prepare a discussion paper examining the relationship between development related charges and housing affordability. The term *development related charge* refers to government imposed charges that are encountered by the private sector when developing real estate. Development related charges can therefore include building permit fees, Development Charges, development application fees, cash-in-lieu of parkland, Section 37 contributions, property taxes, land transfer tax, HST, and others.

This paper explores the economics of home building in the GTA with a view to assessing how new home pricing is established and the relationship between the delivery costs of home building, pricing, and affordability. Affordability in this paper is used as a relative term, and does not refer to any formal definition of “affordable” housing as defined by the Province or others.

NBLC leans on its 42 years of experience in housing market research in Canada in developing this paper. The majority of our experience has been helping developers pinpoint residential product types, positioning, pricing and anticipated sales or leasing rates for new home construction. This experience provides us with the insight that home pricing is related to market supply and demand considerations. These market characteristics ultimately establish how much a purchaser or renter is willing to spend given the features and location of the home and the competitive choices in the marketplace. Understanding this, developers and/ or owners will charge the maximum rent or sale value for a home that the market can bear at any given time, irrespective of the cost of constructing the home in the first place. If the maximum price supported by the market does not produce enough revenue to cover all development costs (including the purchase of land and an attractive profit), the developer will not build the project. They cannot simply increase the price of homes beyond what is supported by the market when faced with rising costs.

Ultimately, supply and demand conditions in the market determine how much a developer can charge a purchaser for a home. This is illustrated by the fact that Development Charges have increased at similar rates in Mississauga and Caledon while low-density homes in Mississauga are twice as expensive on average from what they are in Caledon due to market fundamentals being quite different.

If development costs increase, which can be due to a variety of factors aside from development related charges, developers will discount the amount they pay for a development site. The land value is negatively impacted because other elements of the equation (**Figure i**) are generally fixed: development costs are relatively fixed, the sale price of homes cannot exceed what the market of willing buyers are willing to pay, and a developer is generally unwilling to reduce their required profit expectation.

The impact of rising development costs therefore reduce the residual land value of a project, which is simply the amount that a developer can afford to pay for a development site. Generally, in communities where market pricing supports land values that well exceeds the value of other competing uses (retail, gas stations, low-density residential, etc.), there should be no impact to the viability, pricing, and supply of residential development. In these situations, developers will continue to purchase developable land in the market and charge purchasers an amount that is supported by local supply and demand conditions.

Figure i:

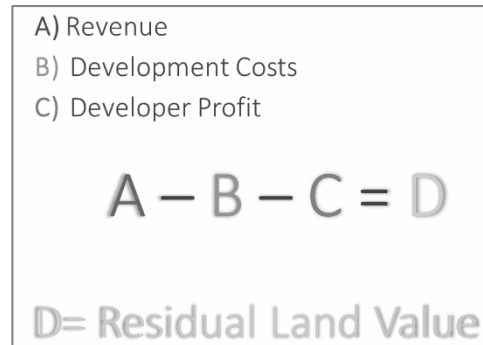

However, if the RLV of a residential development site is reduced below the value of other competing uses or below the expectation of a land owner, a developer will not be able to purchase the property and would not be able to build the project. If the viability of residential development is impacted on a large scale, the supply of housing will be reduced as developers will be unable to build new housing. If supply does not meet demand, the price of both new and existing homes will increase, which is a function of basic housing economics (i.e. a large pool of buyers competing for a comparatively shallow supply of homes). It is noted that NBLC has not assessed the impact of the proposed Development Charge increase on project viability, however the evidence suggests that the impact will vary across the Region’s different market areas.

The City of Mississauga and Region of Peel housing strategies note that a greater supply of housing is needed for low and middle income households. This housing is largely not addressed by the development industry because the market either supports higher pricing, which is pursued by the development industry, or the market does not support higher pricing however the sale values do not provide enough revenue to cover all development costs and an attractive profit. It is possible that if development costs were lower, some of these residential projects would be able to move forward with lower relative pricing. It is important to note that “lower relative pricing” does not mean affordable housing as defined by the City and Region’s housing strategies.

To encourage a greater supply of housing targeted to low and middle-income households, consideration can be given to waiving, reducing, or deferring development costs (e.g. Development Charges) in exchange for developers delivering housing at an explicitly defined affordability level through a Community Improvement Plan (“CIP”) or other similar mechanism. This direction would ensure that only projects that are providing affordable housing would be eligible to receive incentives. A CIP would also allow a flexible approach where different incentives are unlocked depending on the depth of affordability that is provided. These cost savings are directly passed through to the purchaser/tenant, because developers would have to build to a predetermined affordability level.

Reducing development related charges for all development projects in a City is not recommended as projects that do not require the incentives are likely to absorb the cost savings through

increased profit and/or by paying more for a development site. There would be no guarantee that the savings in costs would be passed on to purchasers and the City would lose Development Related Charges that would have to be funded through another source such as property taxes.

1.0 Introduction

N. Barry Lyon Consultants Limited (“NBLC”) with Hemson Consulting has been retained by the City of Mississauga, Town of Caledon, and Region of Peel to prepare a discussion paper examining the relationship between development related charges and housing affordability. The term *development related charge* refers to government imposed charges that are encountered by the private sector when developing real estate. Development related charges can therefore include building permit fees, Development Charges, development application fees, cash-in-lieu of parkland, Section 37 contributions, property taxes, land transfer tax, HST, and others.

The purpose of this discussion paper is to determine the level to which development related charges affect housing prices. The paper will explore the economics of home building in the GTA with a view to assessing how new home pricing is established and the relationship between the costs of building a new home and housing sale values.

While this discussion paper will evaluate all development costs encountered by the building industry, much of the commentary will focus specifically on the impact of Development Charges and cash-in-lieu of parkland. The City of Mississauga is currently undertaking the legislated 5-year review of its Development Charges By-law as well as the cash-in-lieu of parkland policies, which this paper is meant to inform.

To develop this paper, NBLC relies on over 42 years of experience in housing market research in Canada. The majority of our experience has been helping developers pinpoint product types, positioning, pricing, and anticipated sales or leasing rates for new home construction. We also use this research to assess the financial feasibility of projects, determine land/project values, and prepare land acquisition/disposition strategies for both the private and public sectors.

2.0 Background

The following chapter provides background information relevant to the discussion paper. Topics include a description of development related charges, a brief literature review of other reports that have explored similar themes, the affordability context in Peel Region, and trends in home prices and Development Charges in Peel Region.

2.1 Development Related Charges

Development related charges that are imposed on the building industry when undertaking a real estate development can include the following items:

Local and Regional Municipal Charges:

- **Development Charges:** Municipalities collect Development Charges on development to pay for capital costs associated with expanding infrastructure to meet the increased servicing needs of development. Not all municipal services and capital costs are eligible for Development Charge funding. In Peel Region, Mississauga, and Caledon, as with most Ontario municipalities, residential charges are calculated on a per capita basis and differentiated by housing types (e.g. single-detached, apartments, etc.) based on average occupancy patterns. Given the focus of this paper, additional insights are provided to follow.
- **Cash-in-Lieu of Parkland:** Mississauga and Caledon require on-site parkland dedication when a development is proposed in order to accommodate a new park and/or open space. In situations where a development cannot accommodate on-site parkland, a cash-in-lieu payment can be made. New apartment or other higher intensity uses often will pay a cash-in-lieu payment to the municipality, which is required to be paid prior to building permit issuance. Given the focus of this paper, additional insights are provided to follow.
- **Development Application Review Fees:** Local and Regional municipalities will charge fees for the review of development applications, such as Official Plan Amendments, Rezoning applications, site plan control, and committee of adjustment applications. Municipalities are permitted to charge fees to offset the cost of providing land use planning and building code services in accordance with Provincial legislation. As per Section 69 the Planning Act, these fee rates are designed to meet only the anticipated cost to the City in respect of the processing of each type of application. This ensures that such costs are not borne by tax payers.
- **Building Permit Fees:** Similar to the above, building permit fees are also charged to offset the costs to the municipality of administering and enforcing the building code. This process typically involves one or more inspections of the building site as well as processing and administration of the building permits. As per the Building Code Act, municipal building permit fee rates are designed to not exceed the anticipated costs of administration and enforcement of the Building Code.

- **Section 37 Contribution:** Section 37 of the Planning Act allows municipalities to request community benefits in exchange for heights/densities above the existing zoning permissions. Section 37 contributions can include on-site community benefits such as a community facility or streetscape/park improvements. Section 37 contributions can also include a cash payment that will be used by the municipality to address various City-wide needs. In Mississauga, the City's highest priority is that the community benefit be located on-site or in the immediate location. It is noted that not all development projects will include a Section 37 contribution. It is also important to note that when a contribution is required, the contribution (payment or on-site benefit) is meant to be a reasonable proportion of the increase in value as a result of the increase in height/density. However, there is no standard calculation or methodology for calculating the payment/benefit.
- **Public Art (or similar) Contribution:** Some municipalities require a contribution from developers for the implementation of public art or other similar initiative. The City of Mississauga strongly encourages for the inclusion of public art in developments with greater than 10,000m² in gross floor area, with the exception of non-profit organizations and social housing. Developers are encouraged to include public art as part of their development and/or contribute an agreed upon amount of the construction costs to the City's Public Art Program. The suggested contribution is equal to 0.5% (at a minimum) of the Gross Construction Costs of the Development.
- **Property Taxes:** Developers will pay property taxes on a development site as soon as the property is acquired. Taxes will also be paid during application review and construction, ceasing once the new homes are transferred to the purchaser, at which time purchasers begin paying property taxes on their individual unit.

Provincial and Other Development Related Charges:

- **Land Transfer Tax:** Developers pay the provincial land transfer tax when acquiring a development site. Additionally, the land transfer tax is also paid by purchasers when closing on their home. First time home-buyers are however eligible for a rebate on all or part of the land transfer tax, to a maximum rebate of \$4,000.
- **Tarion Enrolment Fee:** Tarion requires developers of new homes in Ontario to pay an enrollment fee, which varies depending on the value of the home as per the Enrolment Fee Calculation Table. The purpose of Tarion is to protect consumers of new homes by ensuring that builders comply with provincial legislation and building codes.
- **HST:** New home sales in Ontario are subject to the Harmonized Sales Tax of 13%. A rebate on this tax is provided, which varies depending on the sale value of the home. The advertised price of new homes typically include the HST amount in the purchase price.

2.1.1 Development Charges – Additional Insights

Development Charges are fees imposed on development to fund “growth-related” capital costs and to pay for new infrastructure and facilities to maintain existing service levels. In Ontario, municipalities impose development charges under the *Development Charges Act, 1997* (DCA) and the accompanying Ontario Regulation 82/98.

Like many two-tier municipalities, development in Peel Region is subject to Development Charges imposed by the upper-tier municipality for Regional services and infrastructure (e.g. Water, Waste Water, Regional Roads, Police, Paramedics, etc.) as well as the lower-tier municipalities for their respective services (e.g. Library, Fire, Recreation, Transit, Public Works, Local Roads, Storm Water Management services, etc.). In addition to municipal services, development in Peel Region is subject to Development Charges levied by GO Transit as well as Education charges levied by the local school boards.

The principle behind Development Charges is that “growth pays for growth” so that the financial burden of growth-related capital costs are not borne by existing tax or rate payers. It is noted that only the initial construction of new growth-related infrastructure may be funded through Development Charges; any subsequent maintenance or rehabilitation costs are the funded through property taxes, user fees, or other municipal funding sources.

Development Charges are a primary source of funding for growth-related infrastructure. As such, any reduction or discount from the fully calculated development charge rates typically results in a revenue loss to the municipality. The growth-related infrastructure costs that would otherwise have been funded through development charges would need to be funded through other means, such as property taxes. Development Charges play an important role in maintaining reasonable property tax and user fee rates while ensuring that overall service levels are maintained as municipalities experience population and employment growth.

Like many municipalities in Ontario, the Region of Peel, Mississauga, and Caledon have different residential Development Charge rates for different housing types (small unit, apartment, other residential, single or semi-detached). This is reflective of each unit type’s respective demand for services: the Development Charge rates are first calculated on a per-capita basis and then converted to a variable charge by housing unit type based on unit occupancy factors. Single-detached dwellings have a higher occupancy rate than apartment dwellings, and therefore these units place a greater demand on municipal services and are charged accordingly.

The DCA requires that the Development Charge by-law and rates be reviewed every five years at minimum. In addition to these five-year reviews, municipalities typically index their Development Charge rates on an annual or semi-annual basis in line with the Statistics Canada Non-Residential Building Construction Price Index, as permitted under the DCA. As a result, there has been an upward trend in Development Charge rates in most Ontario municipalities due to increasing construction costs and land values in recent years. This is consistent with the broader increases in constructions costs and other fees experienced by the development industry.

Under the DCA, Development Charges are payable at issuance of the first building permit. Municipalities may require Development Charges for engineered services (e.g. Water, Waste Water, Storm Water Drainage, Roads and Road Related services) to be paid at the time of draft plan of subdivision or consent agreement if this is provided for under the Development Charges by-law. It is common for municipalities to charge Development Charges for engineered services at the time of subdivision agreement; as there is often a significant time lag between subdivision agreement and the issuance of the first building permit. This practice is helpful in funding the significant up-front costs typically associated with engineered infrastructure that is required to enable development to occur.

It is noted that the DCA is currently being reviewed by the Province and the analysis in this report is based on the prevailing legislation.

2.1.2 Cash-in-Lieu of Parkland – Additional Insights

Public parks and green space are an important component of urban development in a municipality. As municipalities grow, they require additional park space for current and future residents. Municipalities therefore will typically require park space to be included in many new developments. This is done in accordance with Section 42 of the *Planning Act*.

Where on-site parkland cannot be provided, such as in the case of high-density apartment developments, municipalities may instead collect cash-in-lieu of parkland. The City of Mississauga, for example, collects cash-in-lieu of parkland on a per-unit basis for medium to high density residential development. For single detached and semi-detached residential dwellings, the cash-in-lieu rate is 5% of the market value of the lands. Cash-in-lieu funds collected are then used by the City to purchase additional parkland, or make improvements to existing parkland, in order to maintain service levels as its population grows.

It is noted that while development charges may be applied to growth-related parkland development, Development Charges cannot be used to fund the purchase of land for the purposes of park development as this is typically done through parkland dedication or cash-in-lieu. This prevents any duplication of fees or charges.

2.2 Literature Review – Development Related Charges and the Impact on New Home Prices

The building industry regularly raises the issue that housing affordability in Ontario has been declining as a result of increasing development related charges. The following briefly highlights three of the key documents on this topic.

2.2.1 Government Charges and Fees on New Homes in the Greater Toronto Area (May 2018) – Altus Group Economic Consulting prepared for the Building Industry and Land Development Association

Altus Group Economic Consulting (Altus) was retained by the Building Industry and Land Development Association (BILD) to review the government charges and fees on new homes in the Greater Toronto Area (GTA). The purpose of the report was to identify the charges imposed by different levels of government on the development of new homes.

The report identifies that government fees and charges account for roughly 21.7% of the price of a new single-detached home and approximately 23.9% of the price of a new condominium apartment across the six sample municipalities evaluated (Oakville, Brampton, Markham, Bradford West Gwillimbury, Ajax, and Toronto). The report further notes that the most significant government charge for new homes are Development Charges, which can typically comprise 23% - 45% of the total government charge on new homes.

The report notes that government charges and housing prices have not increased at the same rate, with the price of low-rise homes increasing at a higher rate than government charges between 2013 and 2018. Conversely, government charges have increased at a higher rate than high-rise home prices over the same period.

Altus Group isolates the government charges into two distinct categories:

- **Charges imposed on land owner/ developer / home builder:** Typically 46% - 51% of government charges are paid for by this group. These charges include Development Charges, building permits, planning approval fees, parkland dedication, and others.
- **Charges imposed directly on purchasers:** Will account for the remaining 49% - 54% of government charges. These charges can include CMHC mortgage insurance, HST, land transfer tax, and others.

The report concludes with the following commentary for each category of government charge:

Government charges imposed on land owners/developers/home builders can have direct impacts on the price of new housing, as increased costs are likely to get passed on to new home buyers where the market will allow for increase house prices. Where the housing market may not allow for increase house prices, homes will either become more difficult to market, prices will have to moderate, or developers will have to absorb the additional costs.

Charges imposed on new home buyers increase the costs of home ownership and reduce the amount of income available to pay on-going mortgage costs, as well as other costs of living. Additionally, where charges imposed on developers/home builders are passed on to home buyers through higher prices, home buyers will have both a higher mortgage principal to repay, but will also have higher interest costs associated with a higher mortgage.

The report appears to take the position that housing costs and new home prices are directly linked. However, aside from identifying the increase in average new home prices over the past

decade, the report does not acknowledge how the private sector establishes the price of new homes or the impact of market forces (e.g. supply and demand characteristics) on home prices. Similarly, the conclusions assume that increasing development costs will be passed on to new home buyers if the market supports a price increase. However, no acknowledgement is given to the fact that if the market could support higher pricing, developers would exploit this pricing irrespective of costs.

2.2.2 City of Vancouver City-wide DCL Rate Update: Evaluation of Potential Impacts on Urban Development (June 2017) – Coriolis Consulting Corporation prepared for the City of Vancouver

Coriolis Consulting Corporation (Coriolis) was retained by the City of Vancouver to evaluate the financial ability of new development projects in the City to support an increased Development Charge Levy (DCL) rate. The City of Vancouver charges DCLs on new development to generate revenue for infrastructure costs associated with new urban growth. DCLs are therefore similar to Development Charges in the Ontario context. Housing affordability is also a major issue in the City of Vancouver, with the City often cited as one of the least affordable global housing markets.

The Coriolis report acknowledges the widespread perception that development levies can have a direct impact on the cost of new development, where increasing costs will result in a corresponding increase in residential prices. However, the report acknowledges and addresses the fact that the market dynamics impacting home prices are much more complex. The report makes the following economic observations:

- 1. In a competitive marketplace, developers cannot simply add the cost of a levy onto the asking prices for new floor space. Adding the levy on to the asking price would imply that purchasers are willing to pay more for “levied” space than they would pay for comparable space in comparable neighbourhoods with lower (or no) levies. This, of course, does not happen. Unless someone has a monopoly on a commodity, prices are set by the interaction between supply and demand; no supplier can unilaterally determine price simply because costs are higher. In a sense, a levy in a particular area is no different than if the area had unusually poor soil conditions and therefore above average construction costs. Prices in the affected area will not be arbitrarily higher than in directly competitive areas simply because costs are higher. Something else must “give”.*
- 2. While developers pay the levy when they obtain project approval, they will seek ways to transfer the impact to others, because developers require a profit margin to make development an attractive business. Being neither willing to absorb the levy as a reduction in profit nor able to simply add a surcharge on end prices for their products, the first response of developers to a levy is to lower the bid price for development sites by an amount equal to the levy. The primary impact of levies, therefore, is to put downward pressure on the value of properties for redevelopment. As noted earlier, this is no*

different than a developer's response to the fact that an area has worse soils conditions than comparable areas. A developer will be willing to pay less for such sites, by an amount equal to the cost of remedial work (e.g., piling, drainage, excavation, or extra construction costs) needed to make the net cost of the site equivalent to comparable land with no soils problems.

- 3. It is the land market's response to the downward pressure on land value that mainly determines the ultimate impact of a new (or increased) levy. If the same amount of land remains available for new development projects (i.e., available for sale at a price developers are willing to pay) after the introduction of a levy, broadly speaking the supply of new product to the market should be unchanged and there will not be an impact to the price of new floor space. Developers experience the same total project cost (albeit made up of different line items) as they would face without the levy, the same amount of new development happens, and there is no reason for demand to change, so prices to consumers and profits for developers remain where they were before the introduction (or increase) of the levy. Only the land value supported by redevelopment changes.*

However, if the downward pressure on land value for development sites means that less land is available for new development after the levy (because the reduced offered price for land results in less land being available on the market), the supply of new product will be reduced. This leads to rising prices for all existing and new supply, not just for new floor space.

The Coriolis study provides contrasting position to that of the Altus report. Ultimately, the Coriolis study concluded that the impact of increased DCLs on the apartment market in Vancouver will vary based on the project location/market context and achievable density.

2.3 Affordability Context in Peel Region

The Region of Peel completed a Housing Needs Assessment in the spring of 2018, which informed the Region's updated Housing and Homeless Plan as well as the Peel Housing Strategy. Similar to many municipalities in Ontario, the Housing Needs Assessment identified an affordable housing need for low and middle-income households. Specifically, the needs assessment determined that approximately 70% of low-income households (less than \$59,110 before taxes) and 29% of middle-income households (\$59,111 - \$105,922) cannot secure housing that is affordable to their income level.

The City of Mississauga has also prepared a housing strategy ("Making Room for the Middle – 2017") designed to address housing for middle income earners (\$55,000 - \$100,000 annual household salary). The report targets the development of homes priced between \$270,000 and \$400,000 to maintain affordability for these middle income households, which currently do not exist in the market aside from some condominium apartments and a limited selection of townhomes.

It is important to understand that “affordability” is a relative term. Housing for low-income households (“deep affordability”) will often require significant public-sector financial incentives/contributions to be viable. This depth of affordable housing is rarely supplied by the private-sector outside of non-profit and cooperative housing providers and government agencies (e.g. Peel Living). Due to the significant costs of operating and maintaining deep affordable housing, and the significant financial resources required to construct new units, the supply of this housing often falls short of demand. This results in large waiting lists for deep affordable housing.

Moderate affordable housing, which targets the middle segment of the income spectrum, also often falls short of demand. This housing often falls within the definition of “the missing middle” and was the focus of Mississauga’s housing strategy. Housing at the prices identified in Mississauga’s housing strategy (\$270,000 - \$400,000) is often not supplied by the market due to the following considerations:

- The market supports higher pricing, which is pursued by the development industry; OR
- The market does not support higher pricing, however the pricing level does not provide enough revenue to cover all development costs, the purchase of land, and produce an attractive profit. In this scenario, financial incentives and other non-financial tools are necessary for the project to be viable and therefore to encourage private-sector participation at this affordability level. Local programs as well as programs from senior levels of government (e.g. Investment in Affordable Housing, National Housing Strategy) attempt to address this issue.

To address the latter scenario, many municipalities and provincial/federal programs have investigated strategies to lower development costs or provide direct financial support (e.g. capital grants) to qualifying affordable housing projects. Both the Peel and Mississauga housing strategies propose a number of incentives ranging from making lands development ready through pre-zoning, providing public lands for development, implementing inclusionary zoning and other affordable housing policies, encouraging second units, providing financial incentives, and many others. While these strategies can be effective at encouraging a greater supply of affordable housing, this discussion paper focuses on market housing supplied by the private sector.

2.4 Trends in New Home Prices and Development Costs in Peel Region

As illustrated by **Figure 1**, both home prices and Development Charges have been on the rise in Caledon and Mississauga since 2010.

Figure 1 (continued on following page)

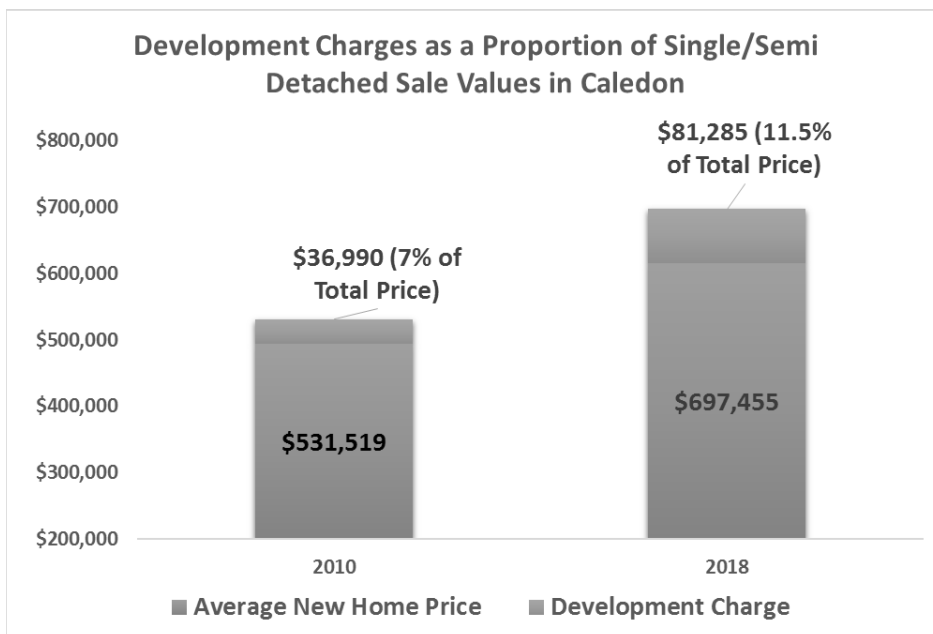
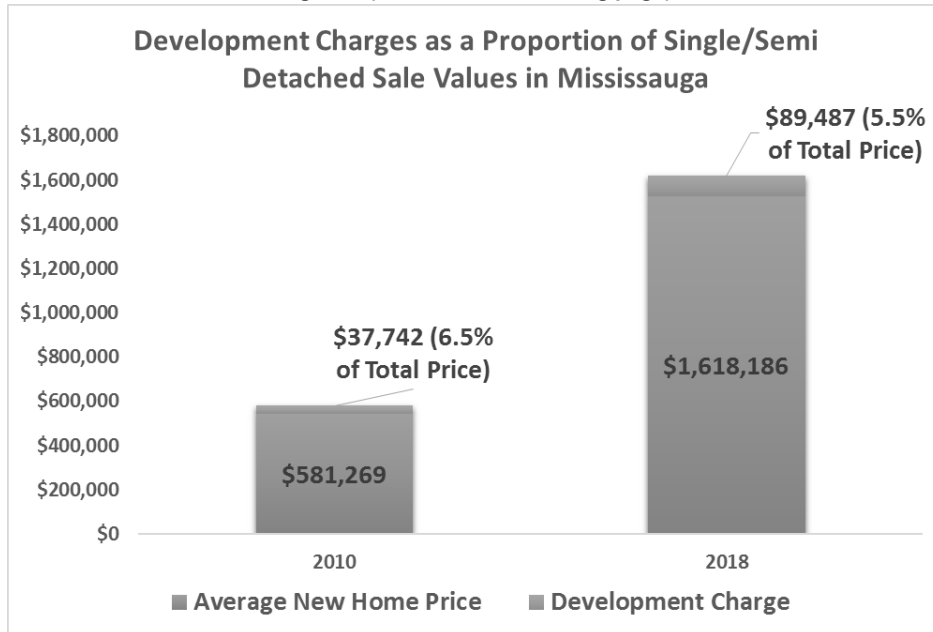

Note: Caledon Development Charge includes both water and wastewater servicing however the average housing price may include properties that do not have Regional water/wastewater services

Figure 1 (continued from previous page)

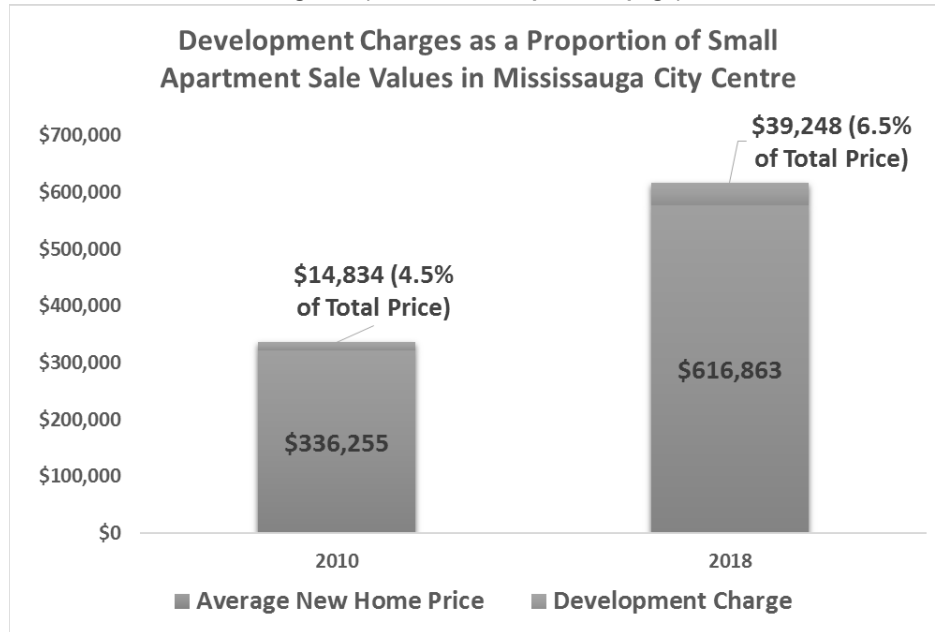

The three charts illustrate how the different market areas have trended since 2010, with the average price of a single and semi-detached home increasing by 178% and 31% in Mississauga and Caledon respectively over this time. New condominium apartments in Mississauga City Centre have increased by approximately 83% since 2010.

At the same time, Development Charges have also been increasing in both municipalities. Overall, the rate of increase over the past 8 years has been similar in both municipalities for all housing types. The Development Charge for single and semi-detached homes have increased by 137% and 120% and apartments have increased by 112% and 106% in Mississauga and Caledon respectively. The Development Charge for a small unit, which could be an apartment, townhome or any other unit under 700 square feet (Mississauga definition) or 750 square feet (Peel definition), has increased by 165% and 135% in Mississauga and Caledon respectively. Currently, Development Charges in Mississauga are marginally higher than in Caledon (see **Appendix D** for more data).

Figure 1 also illustrates the current and historical proportion that Development Charges represent of the average sale price of new homes. Due to the fact that Development Charges have increased at a quicker rate than new single/semi-detached home prices in Caledon, the Development Charge as a proportion of the average sale value is now higher than it was in 2010. Development Charges comprised only 7% of a new single/semi-detached home price in 2010, which has grown to 11.5% as of 2018. This trend is also observed for new apartments in Mississauga City Centre, however the proportional change has been more modest (4.5% in 2010 and 6.5% in 2018).

The exact opposite trend has been observed for single and semi-detached homes in Mississauga, where Development Charges accounted for around 6.5% of the purchase price in 2010 and only 5.5% in 2018. This is due to the fact that home prices have increased more rapidly than Development Charges.

2.4.1 Hard Construction Costs Trends and Observations

It is important to note that in addition to rising Development Charges, virtually all costs that a developer encounters are increasing on an annual basis. These costs include consultant fees, financing costs, construction costs, and many others. While the rate at which these others costs are increasing will vary, they also contribute to the cost of delivering housing.

For example, hard construction costs have been increasing as illustrated by **Figure 2**. Cost consultants Turner and Townsend have provided historical hard construction cost estimates for high-rise apartments and single/semi-detached homes in Peel Region. While these costs have typically increased around the rate of inflation between 2010 and 2016 (1-2%), construction costs have increased more significantly in recent years (5% - 6%). The recent growth in construction costs have been due to macro-economic trade impacts, labour shortages, competition amongst builders, rising price of materials and commodities, and other similar factors. Some reports have noted that costs have increased even more rapidly over the past two years.

Figure 2

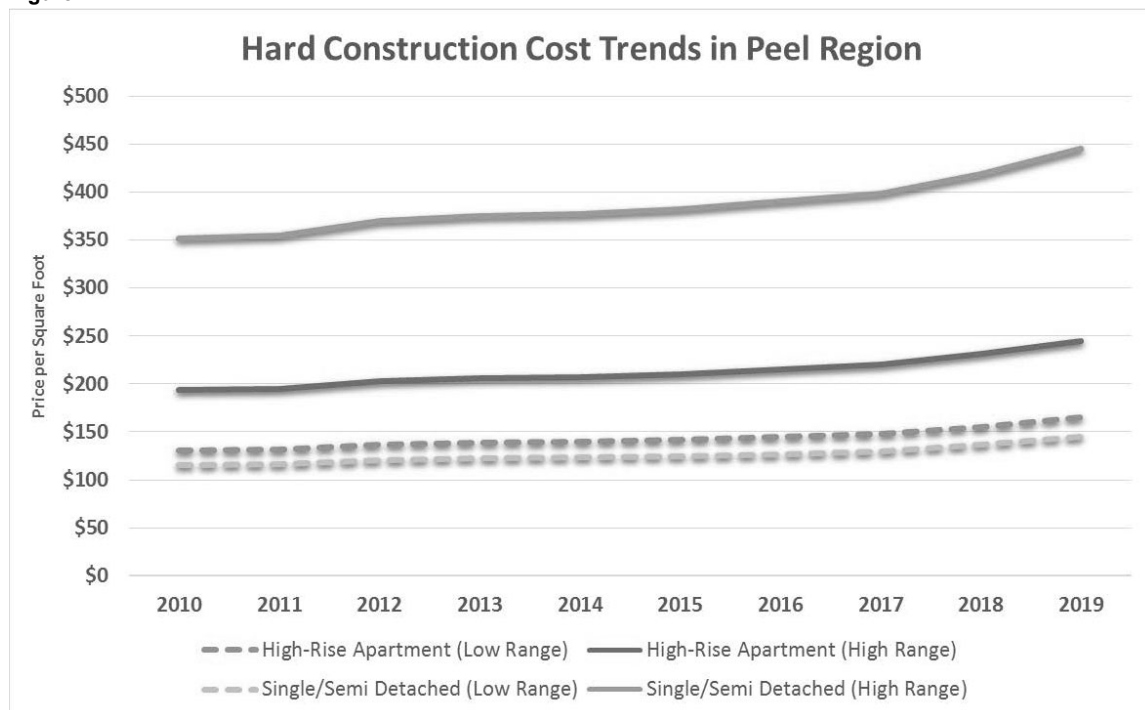

Source: Turner & Townsend; Notes: Cost per square foot of buildable GFA; does not include soft costs; Rates assume typical standards/condition and assume ideal soil and site conditions, rates have not been adjusted to current dollars.

To illustrate the impact of rising construction costs, consider the following example. Assuming a single/semi-detached home size of 1,800 square feet and the low-end¹ of the range provided in **Figure 2** (\$150 per sq.ft.), this home would cost approximately \$270,000 to build (in addition to other site preparation costs, soft costs, developer profit, and land purchase), relative to a Development Charge of nearly \$90,000. While these hard construction costs have increased by around 26% since 2010, the higher rate of growth experienced over the past two years is having a significant impact on the overall delivery cost of housing.

¹ Low-end of the range has been used due to the fact that the high-end of the range (\$420 per sq.ft.) would represent a super-luxury product. The Altus Cost Guide for 2019 recommends a hard cost price range of \$115-\$215 per sq.ft. for a single-family home with unfinished basement and over \$400 per sq.ft. for a custom built single family home.

3.0 Housing Prices and Costs – The Factors Influencing these Fundamental Inputs of Real Estate Development

This section reviews how home prices and costs are established and the connection between these two fundamental factors that impact real estate development.

3.1 Housing Prices Are Determined By Market Demand – Not Costs

NBLC has over 42 years of experience completing housing market research in Canada. The majority of our experience involves assisting private developers with determining highest and best use of their property through market research and analysis. We arrive at the highest and best use by determining the most marketable housing types, achievable pricing, product positioning (e.g. mid-market, luxury), sales absorption rates, target purchasers and marketable suite mix, required project amenities, and other similar items. Often, we use these inputs to prepare a financial pro forma analysis to determine project viability, land values, and profit.

When deciding how to price homes, it is important to consider both demand and supply conditions in the local market area. This generally involves an analysis of the following:

Demand

Supply

- Population Growth and Projections
- Demographics and Incomes
- Target Purchaser Groups
- Purchaser Preferences
- Local Employment Opportunities
- Property Market Strengths and Weaknesses
- Neighbourhood Amenities
- Project Location
- Lending Rates and Regulations
- Future/Planned Transit and Infrastructure Investments

- Sale values and absorption of other marketing projects "the competition"
- Project positioning, interior features and finishes, and amenities of competitive projects
- Provision of parking/storage lockers and associated pricing at competitive projects
- Sale values and market performance of resale homes "secondary competition"
- Review of development applications to understand future supply "future competition"
- Assess growth and land use policies impacting future development patterns

The process of establishing pricing typically begins by characterizing the demand-side of the market, which includes identifying target purchasers (e.g. first-time buyers, young professional singles and couples, families, move-down buyers, seniors), assessing recent growth patterns and projections, defining the market strengths and weaknesses of the site and area (e.g. nearby schools and parks, strong regional employment opportunities, transit improvements are proposed nearby, busy intersection/traffic congestion, etc.), preferences of target purchasers (e.g. mid-rise buildings, stacked townhomes, high-rise towers), impact of lending rates and regulations (e.g. mortgage stress test impact on pool of first-time buyers, foreign buyer tax impact on investors, etc.), and other similar analyses.

Once the demand-side has been adequately characterized, the supply of housing in the local market is assessed. This is completed by surveying other comparable housing developments that are actively marketing to understand how the competitive supply is priced, the rate at which product is absorbed by the market, the positioning and amenities included, and other design/market features that warrant review.

Understanding the resale market is also an important consideration, as purchasers will often consider both a new-build and an existing home when making a purchase. Pricing must therefore remain competitive with both comparable existing homes and other new housing developments. Other factors such as proposed development projects, price trends, future transit investments,

growth management and land use policies, and other similar considerations are also evaluated when determining how to price and position a new housing development.

Ultimately, developers are seeking to determine the maximum they can charge purchasers and still sell their project within a predetermined time frame. If a developer sells very few homes, this is generally a sign that pricing was too high for the project (or some other project flaw). On the other hand if the entire project sells out immediately, the developer may have priced the project too low. Developers carefully examine supply and demand to ensure this does not happen, instead charging the maximum the market will bear to achieve a healthy sales absorption. Developers also monitor supply and demand conditions throughout a sales campaign, often increasing pricing throughout the process at specific thresholds (e.g. at 50% sales, 70% sales, beginning of construction, completion of construction). Some developers will also not release all units within a development project at the same time, in order to adjust pricing or other elements based on the market experience of the initial phase. This is an important consideration, as developers can, and often do, increase pricing if the market supports such an increase, regardless of any shift in development costs.

In conclusion, the development costs associated with a project never come into consideration when determining the achievable market price of a new home.

3.2 Factors that Influence Housing Development Costs

The costs of building housing generally fall into one of four discrete categories:

1. Hard Construction Costs
2. Soft Development Costs
3. Developer Profit
4. Land Cost

The following provides a brief description of each cost category, including commentary related to how these costs are determined.

3.2.1 *Hard Construction Costs*

Hard construction costs encompass all of the materials and labour required to physically construct a building. These costs include construction contracts, building materials, appliances, site servicing, landscaping, site preparation (e.g. demolition, excavation, grading), parking, and other related costs. Hard construction costs will vary from project to project as factors such as topography and grading, geotechnical issues, site contamination, building materials (e.g. concrete vs wood), the height of a building, surface vs. underground parking, and other similar considerations can all impact construction costs.

Hard construction costs are dictated by the market, albeit a different market than home prices:

- Developers will purchase building materials in the market like any other commodity, which are subject to fluctuations in price. Macro-economic trade impacts (e.g. steel tariffs) can also impact the price of materials and other commodities.
- Similar to building materials and commodities, developers must pay the market price for labour, which can fluctuate based on availability, unions, and other factors.
- Competition amongst builders can also increase the cost of building materials and specialized labour under particular supply and demand conditions.

Overall, once the specifics of a development project are well known, hard construction costs become relatively fixed.

3.2.2 *Soft Development Costs*

Soft development costs include all of the other costs that a developer will encounter when developing real estate. These items include the government imposed development related charges identified earlier in this paper, as well as a host of other costs such as:

- The consultant team - typically consisting of urban planners, architects, urban designers, landscape architects, engineers, lawyers, public consultation experts, and others.
- Project marketing costs (e.g. sales centre, news ads, billboards, radio advertisement, etc.).
- Sale commission fees – paid to the sales team hired by the developer.
- Construction financing costs.
- Development and construction project management.
- General overhead and cost contingency.
- General legal fees.
- Project/construction insurance costs.
- Others.

Similar to hard costs, soft development costs can also shift depending on the specific development project. Factors such as project scale and absorption rates can impact development timing, which can affect financing and other carrying costs. These costs can also shift depending on the approvals required, size of the property (e.g. building permit fees), value of the land (cash in lieu of parkland), the section 37 agreement negotiated, rising Development Charges, and others.

Rising development related charges therefore directly increase the soft development costs of delivering new homes.

3.2.3 Developer Profit

Developers require a certain profit threshold to undertake a development project. They are investing their skill and equity, as well as taking on significant risk in order to make a profit that is superior to the rate of return through some other investment vehicle. In our experience, most active developers seek a target profit of 15% of gross project revenue.

If an acceptable profit cannot be achieved, developers will seek development opportunities in other markets, invest in other real estate classes, or choose another investment vehicle altogether.

3.2.4 Land Acquisition Cost

The value of land is directly connected to the market strength of an area. Typically strong market areas support higher land values than weaker market areas. This is expanded on in the following section.

3.3 The Economics of Real Estate Development

The economics of development are based on two fundamental inputs: revenues and expenses.

Project revenues are driven by the sale value of homes as well as other sources such as parking spaces, storage lockers, and ground-floor commercial space within an apartment building. Once project revenues have been estimated, developers will then begin to calculate all anticipated project costs. As evaluated in the previous section of this paper, these costs will include all hard and soft development costs, the latter of which will include the development related charges. As illustrated by **Figure 3**, developers will then subtract all development hard and soft costs, as well as their required profit from the estimated revenue of the project. The remaining amount, or residual amount, is referred to as the Residual Land Value (RLV). The RLV represents the price a developer could pay for the land to construct the housing project and make an attractive profit.

Figure 3: Development Economics Illustration

A) Revenue
B) Development Costs
C) Developer Profit

$$A - B - C = D$$

D = Residual Land Value

The RLV will result in one of two scenarios:

- **RLV is equal to or higher than the asking price of land in the market:** If the RLV of a proposed development is greater than the asking price of developable land in the market, a developer can, in theory, purchase the land and build the project while also meeting their profit expectation. If a developer is able to acquire land below the supportable RLV, and no cost overruns occur, the developer's profit will be enhanced.
- **RLV is below the asking price of land in the market:** In this situation, the housing development would not be considered viable because a developer would not be able to afford the price of land in the market and still meet their profit expectation. This project would therefore not move forward.

If development costs increase, the amount subtracted from the project's revenue will also increase, which results in a lower RLV. In other words, the developer would pay less for the development site because costs have increased. The RLV is impacted because the other elements of the equation (**Figure 3**) are more or less fixed. Developers are not likely to reduce their profit expectation as discussed earlier in this report. Developers also cannot simply increase the price of homes beyond what the market will support. If the market does support an increase in the price of new homes, developers are likely to increase pricing regardless of any change in development costs.

Instead, developers will pay less for land when faced with rising development costs. Rising costs can be due to rising development related charges, rising hard construction costs, rising interest rates, new government regulations impacting lending practices, and many others. Rising development related charges would be treated no differently than a developer discovering soil contamination issues at a property they are considering purchasing. Similar to the example provided in the Coriolis Report summarized in Section 2 of this report, a developer will not pay market value for a site with soil contamination issues and attempt to recapture the increased cost by increasing the sale value of homes beyond what is supported in the market. Rather, if the soil remediation costs will require \$2.0 million in added project costs, the developer will pay \$2.0 million less for the property, as determined by the impact of the cost increase on the residual land value. The same will be true for any developer who is considering the purchase of a development site knowing that Development Charges are expected to increase the following year(s).

3.4 Discussion

The commentary in this chapter illustrates the differences in how housing prices and development costs are determined in the market. Ultimately, supply and demand conditions in the market determine how much a developer can charge a purchaser for a home. This is illustrated by the fact that Development Charges have increased at similar rates in Mississauga and Caledon, however the market fundamentals for low-density homes in Mississauga are much stronger than in Caledon, which supports new home prices that are twice as expensive on average (**Chapter 2.4 – Figure 1**). The local supply and demand conditions support the level of price growth observed in Mississauga due to the City's strategic location in the region, waterfront accessibility, local and regional transit accessibility, broader employment opportunities, and many other market factors.

If market pricing was determined by costs alone, the price of a single-family home in Mississauga and Caledon would be similar. If market pricing was determined by supply and demand conditions, but developers could unilaterally increase pricing when faced with increasing costs, the price of single and semi-detached homes in Caledon would have increased more rapidly than what was observed between 2010 and 2018. Rather, the market has supported a specific price threshold in both Caledon and Mississauga, which has been met by developers regardless of any shift in development costs.

The impact of rising development costs reduce the RLV of a project, which is simply the amount that a developer can afford to pay for a development site. Generally, in communities where market pricing supports land values that well exceeds the value of other competing uses (retail, gas stations, low-density residential, etc.), there should be no impact to the viability, pricing, and supply of residential development. In these situations, developers will continue to purchase developable land in the market and charge purchasers an amount that is supported by local supply and demand conditions.

However, if the RLV of a residential development site is reduced below the value of other competing uses or below the expectation of a land owner, a developer will not be able to purchase

the property and would not be able to build the project. If the viability of residential development is impacted on a large scale, the supply of housing will be reduced as developers will be unable to build new housing. If supply does not meet demand, the price of both new and existing homes will increase, which is a function of basic housing economics (i.e. a large pool of buyers competing for a small amount of space).

Finally, it is acknowledged that if development costs were lower, it would be possible for some new development to proceed at “lower” pricing. For example, there are many communities in Peel Region that currently do not support viable development. This is due to the fact that the local supply and demand conditions do not support pricing that is able to cover all development costs (including land purchase) and produce an attractive profit. It is possible that if development costs were lower, some of these projects would be able to move forward with lower relative pricing. It is important to note that the lower pricing levels are still determined by the market, however the project might be able to proceed because development costs were lower. Conversely, rising development costs will further erode the possibility of these projects being constructed.

The type of project described above can be supported by the public-sector with financial incentives and other tools to broaden the supply of housing brought to market as identified in housing strategies (e.g. Mississauga’s Housing Strategy: Making Room for the Middle). This topic is expanded on further in Chapter 5 of this paper.

4.0 Development Case Studies in Peel Region

The following chapter has selected six development case studies to illustrate the economic principals discussed in this report. The purpose of this chapter is to exemplify how the development industry determines the built-form of a project (e.g. lot size, surrounding context, planning controls, market), achievable market pricing (e.g. supply and demand conditions), development costs, the supportable land value of the project (i.e. property purchase price), and overall project viability.

The analysis also isolates the relative impact of Development Charges and other development costs on a housing project. In consultation with the City of Mississauga, Town of Caledon, and Region of Peel, we have selected the following case studies to illustrate a broad range of possible housing projects:

- Mississauga - High-rise condominium apartment in Mississauga City Centre
- Mississauga - High-rise condominium apartment in Port Credit
- Mississauga – Mid-rise condominium apartment along the Dundas Street Corridor
- Mississauga – Stacked townhome development in Erin Mills
- Caledon – Mid-rise condominium apartment in Bolton
- Caledon – Single-detached subdivision

For each case study, we have developed a “prototypical” development concept that is considered reflective of local development patterns and market dynamics. The prototype development concept prepared for each case study therefore includes an assumed lot area, building floorplate, density, and unit yield estimate. We have also prepared a market scan for each case study to understand the local market and provide inputs for the proforma analysis. Relevant inputs gained from the market scan include: pricing, suite mix and unit sizes, market absorption, density and height, project positioning, parking requirements, sale values of parking and storage lockers (if applicable), and other relevant items.

The following subsections briefly describe each case study, with the full built-form analysis and market data available in the appendix of this report.

4.1 Case Studies

4.1.1 Mississauga City Centre – High-Rise Condominium Apartment

Mississauga City Centre serves as Mississauga’s downtown and is one of the city’s most vibrant and urban communities. The area offers a variety of retail services at Square One Shopping Centre as well as an art gallery, performing arts centre, post-secondary institution and recreational centres. City Centre also provides access to local and regional transit via the Square One Bus Terminal and the Cooksville GO Train station. In addition to the abundance of services and amenities, City Centre also hosts community festivals and displays of public art at Celebration Square, which contributes to the area’s desirability. Over the past two decades, Mississauga City Centre has experienced a proliferation of high-rise residential activity primarily in the form of condominium apartments.

Figure 4: Mississauga City Centre Prototype

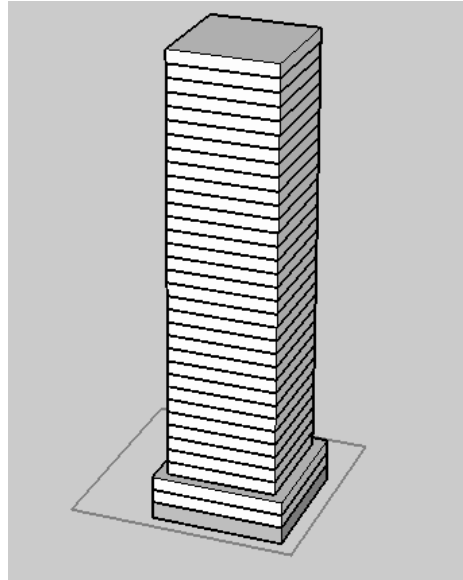

Reflective of many development projects in the local area, as well as planning policies and guidelines, we have assumed a 35-storey tower that accommodates approximately 372 units on a lot size of just under 1 acre. The assumed density is a floor space index (“FSI”) of approximately 6.9. To attract a wide range of purchasers, a broad suite mix will be offered, however the average unit size will be relatively small at 645 square feet overall. It is likely that half of the units offered will qualify as a “small unit” under the Development Charge by-law.

As determined by the market scan, many of the new condominium projects to come to market over the past year have offered units just below \$800 per square foot (PSF) at project launch. Many of these projects have since increased pricing to exceed this threshold, including the Edge Towers project: Tower 1 (323 units) is 82% sold with remaining units currently priced at \$844 PSF and Tower 2 (422 units) is 37% sold with remaining units currently priced at \$874 PSF. The third tower in M City launched last year at an average price of \$792 PSF and is currently 52% sold.

Based on the performance of other projects in the local area as determined by the market scan, we assume the prototype concept can be priced at \$800 PSF at project launch. This would result in an average end-price of \$516,000, however a range of suite types and unit prices would be offered (e.g. \$516,000 for a 645 square foot unit, \$800,000 for a 1,000 square foot unit). This pricing recommendation would be competitive with the supply currently for sale in the market at other competing pre-construction condominium projects (e.g. below the pricing observed at Edge Towers but slightly higher than M City tower 3).

Further, as observed in other marketing projects in City Centre, we assume parking spaces will be provided at a ratio of 0.8 spaces per unit (including visitor spaces) and can be sold for \$35,000 per space with all parking underground. Storage lockers are also assumed to be sold for \$4,000.

The performance of competitive projects in the local area will likely support an absorption rate of 15 units per month over the sales program.

4.1.2 Mississauga Port Credit – High-Rise Condominium Apartment

Port Credit is a highly desirable neighbourhood along Mississauga’s waterfront with high real estate values. The area offers a broad range of commercial and retail services along Lakeshore Road East with access to regional GO Rail service and the proposed Hurontario LRT, which all contribute to Port Credit’s attractiveness. The area has experienced recent growth in higher density formats with the development of high-rise and mid-rise apartment buildings near the Hurontario Street and Lakeshore Road East intersection, including the 185-unit ‘Port Credit Village’ townhouse development on the southeast corner. While the area has experienced limited development activity relative to the broad market appeal, this is due to a lack of easily developable sites and built-form impacts with the adjacent low-density neighbourhoods.

Typical of local projects and the type of development likely to occur in the area looking forward, which was also informed by a review of the Port Credit Built Form Guide, we have assumed a 15-storey tower with approximately 97 condominium units and an FSI of around 5.3. It is likely that new high-rise development in Port Credit will be a modest scale relative to Mississauga City Centre and other locations in Peel Region. Many new projects in the Port Credit area target a more affluent end-user purchaser, largely consisting of seniors and move-down households. As such, larger unit sizes are typical, and we assume an average size of 900 square feet for this development concept. The larger unit size reduces the number of units within the building, and also the number of unit that would qualify as a “small unit” by the Development Charge by-law (assume 25% would qualify).

Figure 5: Port Credit Prototype

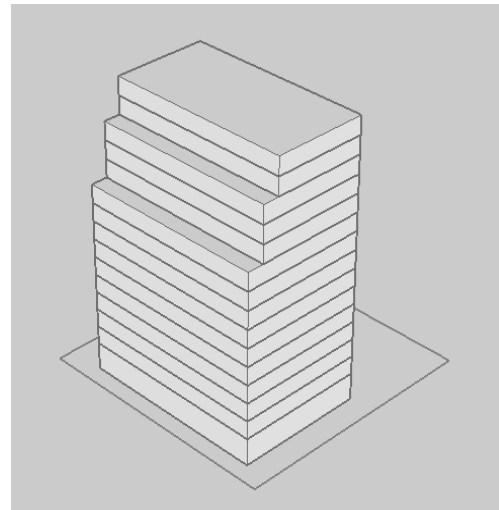

Given the setback and other built-form requirements, as well as the modest building size, we assume a lot area of approximately 0.5 acres with generous front façade setbacks and rear lot setbacks. Parking spaces will be provided at a ratio of 1.25 spaces per unit (reflective of the target purchase group and including visitor spaces) and can be sold for \$35,000 per space with all parking underground. Storage lockers are also assumed to be sold for \$4,000. The performance of competitive projects in the local area will likely support an absorption rate of 7 units per month over the sales program.

As determined by the market scan, there have been few projects to come to market in Port Credit in recent years. However, the two projects that have launched in recent years have carried a

premium over other market areas in Mississauga. Strong pricing and absorption rates are driven by the positive market attributes of the community. We therefore assume the project can be priced at \$850 PSF at project launch, which would result in an average overall end-price of \$765,000. It is expected that some smaller units could be priced lower and some larger suites would be over \$1.0 million.

Tanu is a condominium project currently selling in Port Credit. The project is 15 storeys, contains 204 units, and is priced at \$877 PSF. Since it began sales in October 2018, 71% of the total units have sold. The average unit size is just over 915 square feet. This project, along with the existing condominium apartments in the local area, would be considered the core competitive supply for any new project to come to market. Many of the existing condominium apartments around the intersection of Hurontario Street and Lakeshore and on Port Street are priced between \$700 and \$900 PSF based on recent resale transactions, with much of this supply over ten years old. The positioning of Port Credit Prototype would be competitive with this supply.

4.1.3 Mississauga Dundas Corridor – Mid-Rise Condominium Apartment

The Dundas Street Corridor is a major route within the City of Mississauga stretching almost 20 km from Oakville in the west to Etobicoke in the east. Although there are a variety of retail and commercial services along the Dundas Corridor, there is currently limited market appeal for higher density housing. The few mid-rise apartments that have been developed are mainly concentrated near Cawthra Road or Erin Mills Parkway. However, the City has initiated the Dundas Connects master plan to create a planning framework that is intended to encourage intensification and convert the corridor into a mixed-use, transit-oriented route supported with bus rapid transit. Notwithstanding this initiative, market demand is likely to be modest over the near to mid-term given the current context.

Given the lack of significant market activity, we have also reviewed the Dundas Connects master plan to understand the type of mid-rise development that is expected along this corridor looking forward. This analysis has led us to assume a five storey “slab” style building on a rectangular lot of approximately 1.4 acres. With an assumed average unit size of 800 square feet, the building will yield 95 units with about half of the suites qualifying as a “small unit” by the Development Charge

Figure 6: Dundas Street Prototype

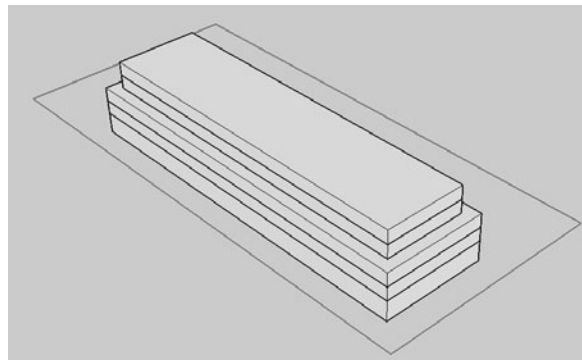

by-law. The average unit size is reflective of the building targeting a larger range of purchasers relative to the Mississauga City Centre and Port Credit case study, which will include small units that are popular amongst investors, first time purchasers, and singles as well as larger suites for seniors, move-down purchasers, and couples/families priced out of the low-density market. The

building has an assumed FSI of 1.5. We also assume the building would be wood-framed, resulting in construction cost savings.

There is only one mid-rise project actively marketing along the Dundas Street corridor, which is The EV Rolaye Condos located on Dundas Street West near the University of Toronto Mississauga campus. The project launched in 2016 at an average price of \$666 PSF and is 86% sold. The remaining 14% of suites are priced \$683 PSF. Overall the project has sold at an average absorption rate of 3.3 sales per month.

We have assumed the prototype building can be priced at \$650 PSF, however the price would include a parking space. Parking would be provided both at surface level and underground and be provided at a ratio of 1.1 spaces per unit (including visitor spaces). The pricing would result in an average end price of \$520,000, with smaller units driving a lower end price and larger units driving a higher end price. The pricing assumed takes into consideration the options that purchasers would have in the market, which includes some older apartments, townhomes, and even a select number of semi-detached homes within the western and eastern segments of the Dundas corridor that are priced between \$450,000 (older apartments) and \$600,000 (townhomes). The pricing level assumed, and the decision to include parking in the purchase price, would allow the project to remain competitive with the local housing supply and achieve an absorption rate of 3 sales per month.

The lack of mid-rise activity in Mississauga is not uncommon and frequently referred to as a “missing middle” housing type in the GTHA context. This is due to developers pursuing higher density projects that offer higher profits or single family projects that are higher priced and comparatively easier to gain approval for and market. Mid-rise buildings will also share many of the same costs as a high-rise project, however the costs are spread over a smaller saleable floor area. They also face competition from other comparable development forms, such as stacked townhomes.

4.1.4 Mississauga Erin Mills – Stacked Townhome

Stacked townhomes are essentially a three or four-storey apartment building that “looks and feels” like a ground-oriented townhome building. These buildings are often “half sunken”, with entrances to units accessible by a small staircase down a level and another set of entrances a half storey above grade. Stacked townhomes can be very attractive to first time purchasers as they are an entry level product offering for young families and professionals. They typically accommodate larger units than condominium apartment buildings, achieve significantly lower maintenance fees due to the lack of amenities, and offer a ground-oriented product type that many purchasers desire. However, given the lack of elevator service and the abundance of stairs, older populations have not responded well to this product.

Stacked townhomes have become very popular in the GTHA as the price of single-family homes have escalated to unaffordable levels. This is also true in Mississauga, which has seen several

stacked townhome projects launch over the past several years. Stacked townhomes are attractive to developers because they can be implemented through a large scale and phased development of multiple blocks or as a modest infill project. Stacked townhomes are also attractive to developers as they can be much cheaper to construct than high-rise or even mid-rise apartment buildings, especially if wood-frame construction is utilized.

We have assumed a smaller scale infill stacked townhome project as a prototype. The prototype therefore includes two three-storey stacked townhome blocks on a 0.5 acre site with an FSI of approximately 0.9. This built-form, including site design and setbacks, is informed by other marketing and built projects in Mississauga and the City's Draft Urban Design Guidelines for Back to Back and Stacked Townhouses.

Figure 7: Stacked Townhome Prototype

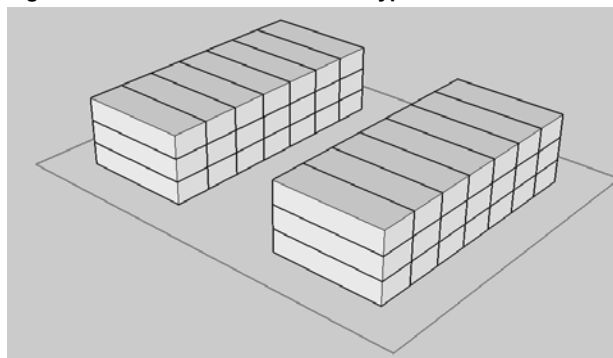

Utilizing an average unit size of 850 square feet, the project would yield approximately 39 residential units. The larger average unit size would accommodate a wide range of smaller one-bedroom units and larger three bedroom suites. It is assumed that only 30% of suites would qualify as a “small unit” by the Development Charge by-law.

There are five stacked townhome projects currently marketing in the City of Mississauga, totalling nearly 650 units. While the average price of the remaining available supply is approximately \$640 PSF, it is noted that location will play a significant impact in how prices are established. Two of the most recent projects to launch in November/December of 2018 launched with pricing between \$640 and \$670 PSF, with the former located in the Clarkson neighbourhood and the latter located in Lakeview. Both of these projects are within a 25 minute walk of a GO Station. Another stacked townhome project (WayUrban Towns) launched in March 2018 within Erin Mills and is currently priced at \$581 PSF.

We have assumed the prototype building can be priced at \$600 PSF and would include a parking space in the purchase price. Parking would be provided both at surface level and underground and be provided at a ratio of 1.1 spaces per unit (including visitor spaces). The pricing would result in an average end price of \$510,000. This pricing would be higher than the WayUrban Towns project currently selling in Erin Mills, however this project has experienced strong sales absorption, selling 120 units in only 10 months and reaching 70% sales (construction financing threshold) in only 4 months. This project launched in March 2018 at an average price of \$525 PSF, which has increased considerably to \$581 PSF at the time of our survey. The pricing level assumed for the prototype, and the decision to include parking in the purchase price, would allow the prototype to remain competitive with the competitive supply in the local area and achieve an absorption rate of 3.5 sales per month.

4.1.5 Caledon Bolton Downtown – Mid-Rise Apartment

Bolton is Caledon’s most populous community with a historic downtown core that has a full complement of local retailers and services with access to several nearby hiking trails and recreational opportunities. The area has a small-town charm while still being in close proximity to larger urban areas. Bolton’s existing residential development is comprised predominantly of single-detached homes on the fringe of the downtown core. In regard to higher density formats, there has only been one condominium apartment building developed in Bolton - River’s Edge by Armour Heights Developments.

River’s Edge is a five-storey and 72 unit adult lifestyle building that targeted more affluent move-down and senior purchasers that began sales in 2007. The majority of units are two-bedroom or larger at an average unit size of 1,128 square feet. The large unit sizes and significant amenity offering (indoor pool, gym, guest rooms, underground parking with car wash, large lobby area, and outdoor landscaped space) is designed to attract local populations that are used to larger living spaces and may require more amenities to be enticed to move to a condominium.

There is a development application for another 5-storey and 73 unit condominium building immediately adjacent to River’s Edge that is currently under review by the Town. While this project has not yet begun marketing, it is likely that it will be positioned similarly to River’s Edge, targeting move-down and senior households in the local and surrounding area.

We have therefore assumed a prototype that shares similarities with these two projects. The prototype includes a five-storey and 72 unit building on a 1.2 acre rectangular site with an FSI of 1.6. The average unit size will be approximately 1,000 square feet given the target purchaser group. One parking space will be included in the purchase price and an additional space will be available for purchase for \$15,000. Parking will be both surface and underground and be provided at a rate of 1.5 spaces per unit (including visitor parking), which will allow some purchasers to have two parking spaces given the rural context. Due to the large average unit size, it is assumed only 20% of units would qualify as a “small unit” by the Development Charge by-law.

Figure 8: Bolton Mid-Rise Prototype

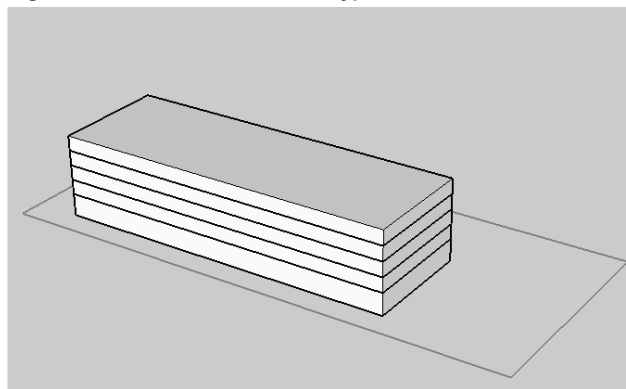

To understand potential pricing, we have reviewed resale data within the River’s Edge project, with units typically selling for under \$700,000 with an index price of between \$610 and \$650 PSF. The units at the higher end of the range took multiple months to sell, with one of the units taking seven months to sell. This indicates that while demand exists at this pricing level, the

market depth is shallow. It therefore appears it would be difficult to market 72 units at a price above \$600 PSF and maintain a healthy absorption rate. We therefore assume an average index price of \$575 PSF, which should result in an absorption rate of 2 sales per month with an average index price of \$575,000.

4.1.6 Caledon Mayfield West – Single-Detached Homes

The Town of Caledon has experienced strong low-density residential housing development through greenfield subdivisions over the past decade. Low-density housing starts in the Town averaged just over 465 units per year between 2010 and 2014, which has increased to an annual average of nearly 610 new units since this time. At the time of our survey, there were seven actively marketing projects in the Town currently selling single-detached homes. In total, there were 1,236 total single-detached lots within these projects, of which 90% were sold, meaning there were only 125 units available for sale. It is noted that most of these projects have a combination of single and semi-detached homes as well as townhomes available for sale.

The Mayfield West area had the largest concentration of actively marketing single-detached projects in Caledon. Three of the seven projects were located in this area, totaling 892 lots (about 70% of the total lots). While there are a wide variety of single-detached homes available for sale in the market, the most popular offering by far is a 36 foot lot ranging in size between 2,300 and 2,950 square feet.

We have therefore assumed a 2,650 square foot single-detached home on a 36 foot lot as the prototype. The subdivision will contain 40 total units and will require 2.0 hectares of land at a density of 20 units per hectare. The project will require on-site parkland dedication of 5% of the lot area and approximately 275 metres of local roads (assumes each home is 36 feet * 40 units = 1,440 feet; assume 2 units on each side of the street and a 25% gross up = 900 feet or 275 metres). We assume pricing would start at \$415 PSF, which result in an end-price of just under \$1.1 million. This pricing would be directly comparable to the Stowmarket Springs subdivision (similarly sized 36 foot lot homes) currently marketing in Mayfield West as well as other competitive projects in Caledon. This pricing would likely support an absorption rate of 2.5 sales per month.

4.2 Analysis

4.2.1 Methodology

NBLC has prepared a financial analysis for each of the prototype development concepts. The methodology utilized in our analysis is a Residual Land Value (RLV) model, which was detailed in Section 3.3 of this paper (**Figure 3**). The objective of the model is to establish a site's estimated land value, assuming a developer requires the current market return rate of 15% profit on gross revenue. This model accounts for all potential revenue attributed to the project and then subtracts all development costs and the developer's profit. The remaining amount is referred to

as the residual land value, which is then discounted to the present day. To show evidence of financial feasibility, we seek to illustrate if a development would meet the following two tests:

1. a developer could earn a target profit of 15% of gross revenues; and,
2. the residual land value derived is equivalent to current market land values.

Regarding the second test, NBLC has surveyed land transactions within the City of Mississauga and Town of Caledon for low, medium, and high-density development (**Appendix C**). The results of the financial analysis will be evaluated relative to these comparable land transactions.

It is important to note that there are situations where a project might not meet the above tests, but a developer would still move forward with the development. This includes a situation where a land owner may already own a property and has capitalized the original cost from its former use as a retail site or some other venture. In these cases, where there is no effective land cost, the combined profit and land value return may still encourage investment.

4.2.2 General Assumptions Common to All Case Studies

The following assumptions are utilized for all of the case studies evaluated. Other site-specific assumptions for each development concept are detailed separately within each pro forma analysis (**Appendix E**):

- The net to gross efficiency is 85% for apartments and 100% for stacked townhomes and single-detached homes.
- A discount rate of 7% is used for all case studies in Mississauga. A slightly higher discount rate of 8% is used for the apartment in Bolton and a slightly lower discount rate of 6% is used for the Caledon subdivision to reflect the different market conditions and overall risk.
- The developer has a target profit of 15.0% of gross revenues.
- Above and below grade hard construction costs are generated using the Altus Construction Cost Guide for 2019; landscaping, contingencies, and other related costs are calculated separately. Local roads and site servicing costs are also calculated using the Altus Construction Cost Guide based on the length of roads within the project, which includes the costs of underground storm, sewer, water, electrical, street lighting, earthworks, curbs, asphalt, and sidewalks.
- Soft costs include all the other costs a developer encounters when developing real estate, such as consulting fees, Development Charges, HST, marketing and sales commissions, and other similar items. These costs are estimated/calculated as per the assumptions detailed in the model.

- The analysis accounts for only the costs and revenues associated with the residential GFA of the project.
- Development Charges are based on the current rates in both Caledon and Mississauga.
- Cash-in-lieu of parkland is \$9,520 per unit for the Mississauga apartment case studies as per the City's current policy. The apartment in Bolton requires a cash-in-lieu payment of 1 hectare per 300 units, with the payment based on the residual land value of the site at the time of permit. The subdivision will include on-site parkland dedication of 5% of the total site area.
- Revenues and costs are inflated by 2% annually. We assume pricing will increase by 3% at the start of construction (for the remaining 30% of suites) and again at construction completion (for all remaining units as calculated by the absorption rate).
- We assume no Section 37 contribution in any of the case studies. Due to the uncertainty associated with the ultimate payment of Section 37, we have not included a cost in the financial model. This does not mean that a payment or other community benefit would not be required. Of note, the policy context in Mississauga City Centre does not provide the City with an avenue to request a Section 37 agreement.
- Parking and lockers are assumed to be saleable for the condominium in Mississauga City Centre and Port Credit only.
- Parking can be accommodated below grade, and no extraordinary costs are incurred in the construction of any underground parking facility.
- All projects are either condominium or freehold in tenure and approvals will be granted for the proposed development concepts.
- We assume all case studies will require a zoning by-law and Official Plan amendment. Applications will also require all other standard applications where applicable (e.g. site plan, subdivision, DARC, Region of Peel review fee, condominium, building permits, etc.).
- We assume that there are no environmental remediation costs incurred by the developer aside from typical demolition and/or site preparation.
- All condominium apartments require a pre-sale of 70% prior to construction beginning.

4.3 Results of the Financial Analysis

Table 1 illustrates the results of the financial analysis for each case study. The full pro forma, including a detailed list of all assumptions and calculations, is available in the appendix of this report. The following describes some of the findings from the analysis.

4.3.1 *Mississauga City Centre and Port Credit High-Rise Condominium Apartments*

Both the Mississauga City Centre and Port Credit markets support high pricing levels as well as a relatively healthy pace of sales. The revenue associated with each project supports a very healthy land value within the Mississauga market once project costs and developer profit is accounted for. The Port Credit scenario supports a land value of \$8.25 million, which is approximately \$80 per square foot of gross buildable GFA, or nearly \$85,000 per unit. The Mississauga City Centre case study supports land value of \$18.0 million, which is approximately \$64 per square foot of gross buildable GFA, or around \$48,500 per unit.

The Port Credit case study results in a higher land value than the Mississauga City Centre prototype on a per square foot and per unit basis due to the following:

- The assumed market pricing is higher on a per square basis for the Port Credit case study;
- The Port Credit case study has lower softs costs:
 - The Development Charges paid, on a per square foot basis, is lower due to the fact that the Port Credit case study incorporates a larger average unit size. There are therefore less units in the Port Credit case study, which results in a lower total Development Charge payment, notwithstanding the fact that there are a lower proportion of units that qualify as a small unit.
 - Similar to the above, the cash-in-lieu of parkland payment is lower for the Port Credit case study because there is a lower unit yield in the building due to the larger unit size. Cash-in-lieu of parkland is currently paid on a per unit basis.
 - Finally, the modest building size and steady absorption rate results in a shorter development timeline for the Port Credit scenario relative to the City Centre prototype. This reduces financing and other carrying costs as well as the period over which the residual land value is discounted.

Reviewing land transactions for high-density residential development in the City of Mississauga (Appendix C), both case studies evaluated here appear to be viable. For example, the Tanu Condominium property in Port Credit sold for \$56 per square foot of buildable GFA (\$56,100 per unit) in 2017. Similarly, multiple land transactions in Mississauga City Centre have ranged from \$17 to \$95 per square foot of buildable GFA (\$15,000 - \$84,000 per unit) over the past two years.

These land values are also higher than the value that would be supported by lower intensity uses in most situations (e.g. retail property, single-storey commercial services, employment use). It is therefore possible that higher costs could be absorbed (effectively reducing the land value of the projects) with project viability being impacted.

Table 1: Summary of Financial Results						
	High-Rise Apartment Mississauga City Centre	High-Rise Apartment Port Credit	Mid-Rise Apartment Dundas Corridor	Stacked Townhomes Erin Mills	Mid-Rise Apartment Bolton	Single-Detached Homes Caledon
Development Stats						
Site Area (sq.ft)	42,679	20,721	59,201	36,597	52,291	215,278
Site Area (acres)	0.98	0.48	1.36	0.84	1.20	4.94
Building Height (storeys)	35	15	5	3	5	2
Total Number of Residential Units	372	97	95	39	72	40
Total Gross Floor Area (sq.ft)	282,531	102,881	89,609	32,938	85,250	106,000
Net Saleable Area (sq.ft)	240,151	87,449	76,168	32,938	72,463	106,000
Net to Gross Efficiency	85%	85%	85%	100%	85%	100%
Total Parking (Visitor + Resident) Surface Parking	298 0	121 0	105 39	43 5	109 34	Parking included in the garages / driveways of homes
Below Grade Parking	298	121	66	38	74	
Parking Ratio	0.80	1.25	1.10	1.10	1.50	
Development Timeline (years)	6.2	5.1	5.6	4.4	5.9	2.8
Suite Mix						
Small Unit	50%	25%	50%	30%	20%	0%
Non-Small Unit	50%	75%	50%	70%	80%	100%
Average Unit Size	645	900	800	850	1,000	2,650
Project Revenue						
Residential Index Price at Project Launch (per sq. ft.)	\$800	\$850	\$650	\$600	\$575	\$415
Average Sale Value at Project Launch	\$516,000	\$765,000	\$520,000	\$510,000	\$575,000	\$1,099,750
Sale Value of Parking	\$35,000	\$35,000	\$0	\$0	\$0	\$0
Sale Value of Storage Locker	\$4,000	\$4,000	\$0	\$0	\$0	\$0
Total Project Revenues (sale of units + parking and storage lockers, interim occupancy charges) (Future\$)	\$214,342,309	\$82,738,992	\$52,402,106	\$20,762,633	\$44,177,634	\$46,740,583
Per Square Foot (Gross GFA)	\$759	\$804	\$585	\$630	\$518	\$441

Table 1: Summary of Financial Results						
	High-Rise Apartment Mississauga City Centre	High-Rise Apartment Port Credit	Mid-Rise Apartment Dundas Corridor	Stacked Townhomes Erin Mills	Mid-Rise Apartment Bolton	Single-Detached Homes Caledon
Project Costs						
Total Hard Costs (Future\$)	\$87,731,403	\$34,775,466	\$22,707,550	\$7,761,453	\$22,132,557	\$20,316,697
Total Soft Costs (Future\$)	\$72,373,396	\$26,000,846	\$17,890,258	\$7,130,924	\$15,032,918	\$14,672,408
Total Development Costs (Future\$)	\$160,104,799	\$60,776,311	\$40,597,808	\$14,892,376	\$37,165,475	\$34,989,104
Per Square Foot (Gross GFA)	\$567	\$591	\$453	\$452	\$436	\$330
Land Value						
Total Residual Land Value and Profit (Future\$)	\$54,237,510	\$21,962,681	\$11,804,298	\$5,870,257	\$7,012,160	\$11,751,479
Developer Profit (Future\$)	\$26,870,007	\$10,342,984	\$6,926,638	\$2,744,077	\$5,839,006	\$6,195,802
Total Residual Land Value (Future \$)	\$27,367,503	\$11,619,696	\$4,877,659	\$3,126,180	\$1,173,153	\$5,555,676
Total Residual Land Value (Present\$)	\$17,993,526	\$8,251,279	\$3,339,058	\$2,321,922	\$747,093	\$4,723,917
per square foot	\$64	\$80	\$37	\$70	\$9	\$45
per unit	\$48,327	\$84,920	\$35,070	\$59,921	\$10,310	\$118,098
per acre	\$18,365,026	\$17,346,386	\$2,456,856	\$2,763,677	\$622,352	\$955,852

4.3.2 Mid-Rise Apartment (Dundas Corridor) and Stacked Townhome (Erin Mills)

The mid-rise apartment has a lower cost base than the high-rise apartments in Port Credit and Mississauga City Centre due to the wood framed construction and incorporation of a mix of surface and underground parking, however the weaker market location along the Dundas Corridor results in lower pricing. This results in a modest supportable land value of \$3.3 million for this case study, which is approximately \$37 per square foot of gross buildable GFA, or around \$35,000 per unit.

By comparison, the stacked townhome prototype supports a land value of \$2.3 million, which is approximately \$70 per square foot of gross buildable GFA or around \$60,000 per unit. The land value is higher than the mid-rise apartment on a per square foot and per unit basis because stacked townhomes are less expensive to construct (lower hard construction cost), the entire GFA is saleable (no common area, elevators, stairwells, etc.), requires less underground parking and the average unit size is slightly larger resulting in less units and lower Development Charges/cash-in-lieu payment (similar to Port Credit discussion).

As noted previously, stacked townhomes are a very popular housing option in the GTHA, and Mississauga specifically. They offer a similar product to mid-rise apartment without the common area amenities, elevators, ground-floor retail, and other features of a condominium apartment. The built-form can therefore be constructed more cheaply than an apartment and will also carry lower maintenance fees, which is attractive to purchasers. The built-form is also more efficient than condominium apartments, as virtually the entire GFA is saleable. These features result in stacked townhomes being very attractive to developers, and also explains why they tend to drive a higher land value than mid-rise apartment buildings.

While stacked townhomes can often be a preferred building type relative to a mid-rise apartment for developers, they may not be appropriate in every situation. For example, stacked townhomes often occur on larger infill sites that are somewhat insular from major roads and include multiple townhome blocks. While they can also front major roadways, like the Dundas Street corridor, municipalities often will not prefer this outcome due to the lack of street animation caused by the absence of ground-floor retail. The units fronting a major road can also be difficult to sell due to noise and other nuisance issues, which might cause the developer to discount the sale price of these units.

A review of land transactions for stacked townhomes in Mississauga indicates that the case study appears to be a viable product in the City. The land value supported by the mid-rise apartment case study also appears to result in a viable project based on a very limited sample of land transactions in the City for mid-rise apartments. However, the land value is much lower than the other Mississauga case studies, indicating that if higher costs erode the land value any further, it is very possibly that a developer would not be able to purchase land in the market to build the project. Further, relative to the high-rise case studies, the profit associated with the mid-rise

apartment is much lower, which further explains why developers have pursued high-rise sites over modest infill apartment opportunities.

4.3.3 Mid-Rise Apartment (Bolton)

Much of the commentary related to mid-rise apartments remains constant between Mississauga and Caledon. Due to the relative affordability of the ground-oriented housing in Caledon, apartments and stacked townhomes have not been a major component of new housing development in the Town. The only apartment building constructed in Caledon, as well as the single application for a new apartment in Bolton, are targeting an older population and therefore elevator access and a strong package of common amenities are required for any project.

Relative to the mid-rise apartment along the Dundas Corridor, the case study in Bolton supports a much lower land value of \$750,000 or approximately \$9 per square of buildable GFA or nearly \$10,500 per unit. While the higher parking ratio results in higher hard construction costs compared to the Dundas Street case study, the soft costs in Bolton are lower due to the large overall unit size assumption (see similar discussion in Section 4.3.1). The cash-in-lieu of parkland payment is also lower in this prototype relative to any of the other case studies because the payment is based on 5% of the value of the land at time of permit; the value of the mid-rise apartment site is modest.

The land value will only result in a viable project if a developer could acquire a development site at the \$9 per square foot / \$10,500 per unit. Currently, this would likely be challenging in the market, albeit not impossible. It is also worth noting that at this land value, other lower intensity uses would compete (gas station, retail, etc.). Any further increase in costs, relative to changes in market pricing, would significantly challenge the viability of mid-rise apartments in Caledon due to downward pressure on the residual land value.

4.3.4 Single-Detached Homes (Caledon)

Finally, single-detached homes remain a strong development option where developable greenfield lands are available in the GTHA. Caledon is no different in this regard, where developers are able to charge a healthy price for new homes as supported by the market. Unlike condominium apartments, there is no market pressure to reach the 70% sales threshold in order to receive construction loan financing. Rather, homes can be built as they are sold and site servicing becomes available.

Construction costs are relatively modest relative to other development forms and pricing is high, as driven by the market. This results in strong pricing and strong residual land values. The residual land value supported by this development concept, which includes a 5% on-site parkland dedication, is approximately \$4.7 million or \$955,000 per acre. The price per acre of low-density land transactions in Caledon have varied widely over the past two years, ranging from under

\$100,000 per acre to nearly \$1.7 million per acre. In areas where market pricing is higher, the value of low-density land can greatly exceed this.

4.4 Observations from the Case Studies

The financial analysis illustrates the economic discussion from Section 3 of this paper. Developers will undertake a significant amount of research to determine what they can build on a property and the eventual highest and best use by accounting for all project revenues, which is based on market conditions, and then subtract all development costs and their required profit to arrive at a land value that they can afford to pay to acquire the development site. In situations such as Port Credit and Mississauga City Centre, as well as stacked townhomes in Mississauga and single-detached homes in Caledon, pricing appears to support a land value that exceeds lower intensity uses. If development costs were to increase, which would negatively impact the residual land value, it is likely that developers would still be able to purchase land in the market assuming the magnitude of impact is not overly punitive.

In other situations, such as mid-rise apartments in Mississauga and Bolton, the residual land value is lower due to lower project revenue as determined by the local market conditions and the built-form. The economics of building these types of projects are already marginal in some cases, and if costs were to increase quicker than market pricing looking forward, the viability of implementing the project will erode even further.

Figure 9 illustrates how total project revenues are broken out as a proportion of individual components (e.g. hard construction costs, soft development costs, developer profit, and the residual land value). As noted previously, if the land is purchased below the supportable land value, the excess project revenue will be absorbed by profit. As demonstrated by **Figure 9**, and consistent with the economic commentary found throughout this report, the developer's profit remains consistent amongst all case studies. Profit is noted at 13% of total project revenue, rather than the 15% threshold identified, because profit is calculated on the sale of units only, net of HST. Once HST is removed from the purchase price, profit is calculated based on 15% of the remaining amount. Profit is also not calculated on revenue from other sources such as parking or storage locker sale.

The hard construction costs as a proportion of total project revenue ranges from 37% for the stacked townhomes (lower construction costs, relatively high sales values) to 50% for the mid-rise apartment in Bolton (moderate construction costs, relatively low sale values). The other case studies range from 41% to 44%. Soft costs were relatively similar for all case studies, ranging from 31% to 34%. Finally, the land values varied widely, from only 3% in the Bolton apartment case study to 15% for the stacked townhome. As noted, the land value is a direct reflection of project revenues and costs.

Figure 10 isolates the soft development costs for each case study, highlighting the seven largest items in this category. HST (with the rebate accounted for) and Development Charges are by far the largest soft costs, representing roughly half of total project soft costs across the case studies.

In addition to Development Charges and HST, construction financing, sales commissions, consultant fees and cash-in-lieu of parkland make up the majority of remaining soft costs. As noted, the subdivision will provide on-site parkland dedication (at a cost), but will not pay cash-in-lieu. The remaining 13%-15% of soft costs are made up of various other items such as property taxes, building permit and development applications, project/construction management, and others.

The proportion of each soft cost fluctuates between the case studies because the total soft costs are not identical. The fluctuation is also observed due to the following:

- The proportion that Development Charges make up of total soft costs is dependent on the average unit size and overall number of units in the project as well as the number of units that might qualify as a “small unit” by the Development Charges by-law.
- HST costs will also fluctuate based on the unit purchase price and calculated rebate (also assessed based on the unit sale value).
- Financing costs will fluctuate based on the overall development timeline, which is why the two high-rise projects have higher financing costs than the small subdivision and stacked townhome project.

Overall, this analysis illustrates that government imposed fees on development, especially HST, Development Charges, and cash-in-lieu of parkland, represent a significant proportion of the total soft costs of delivering new housing.

Figure 9

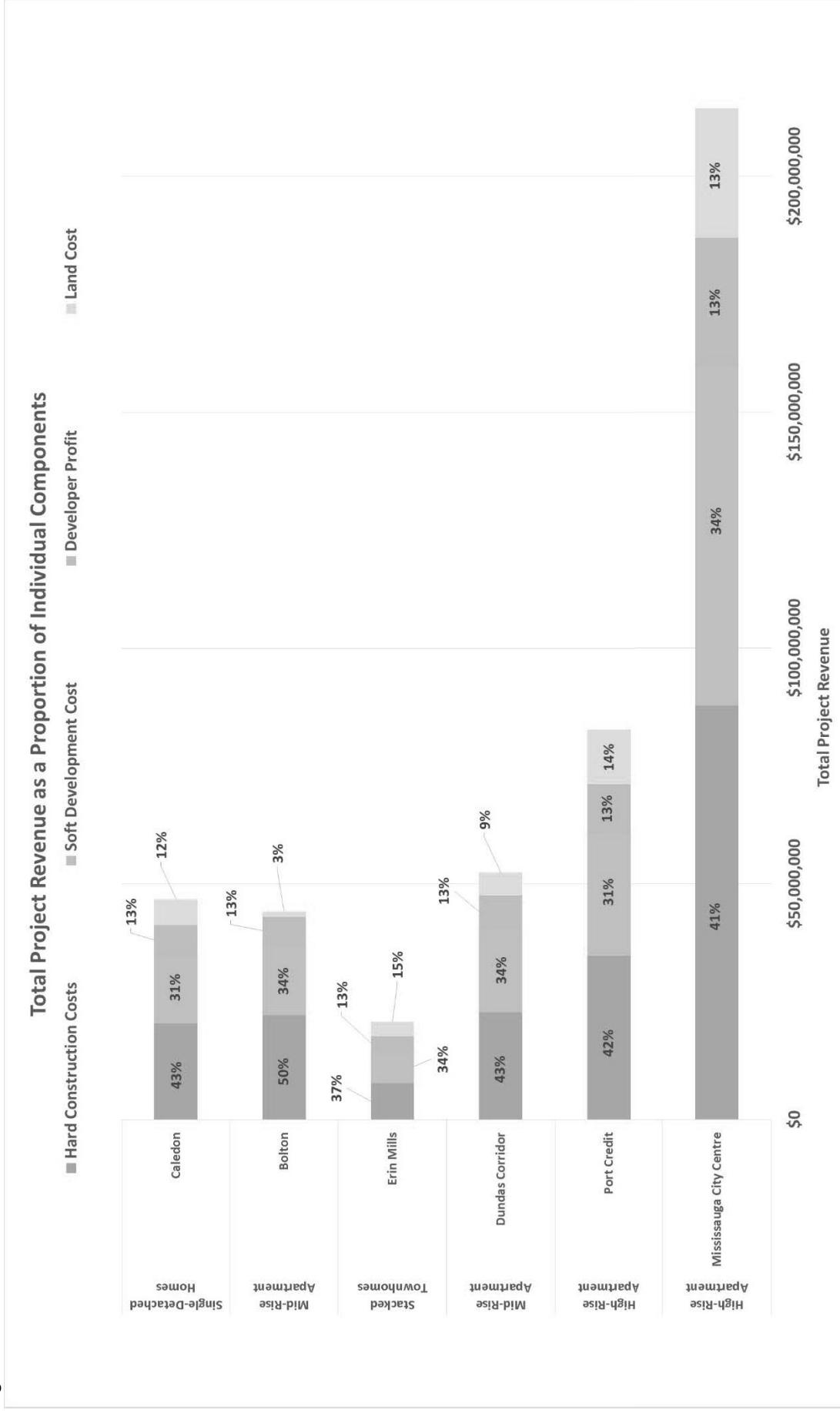
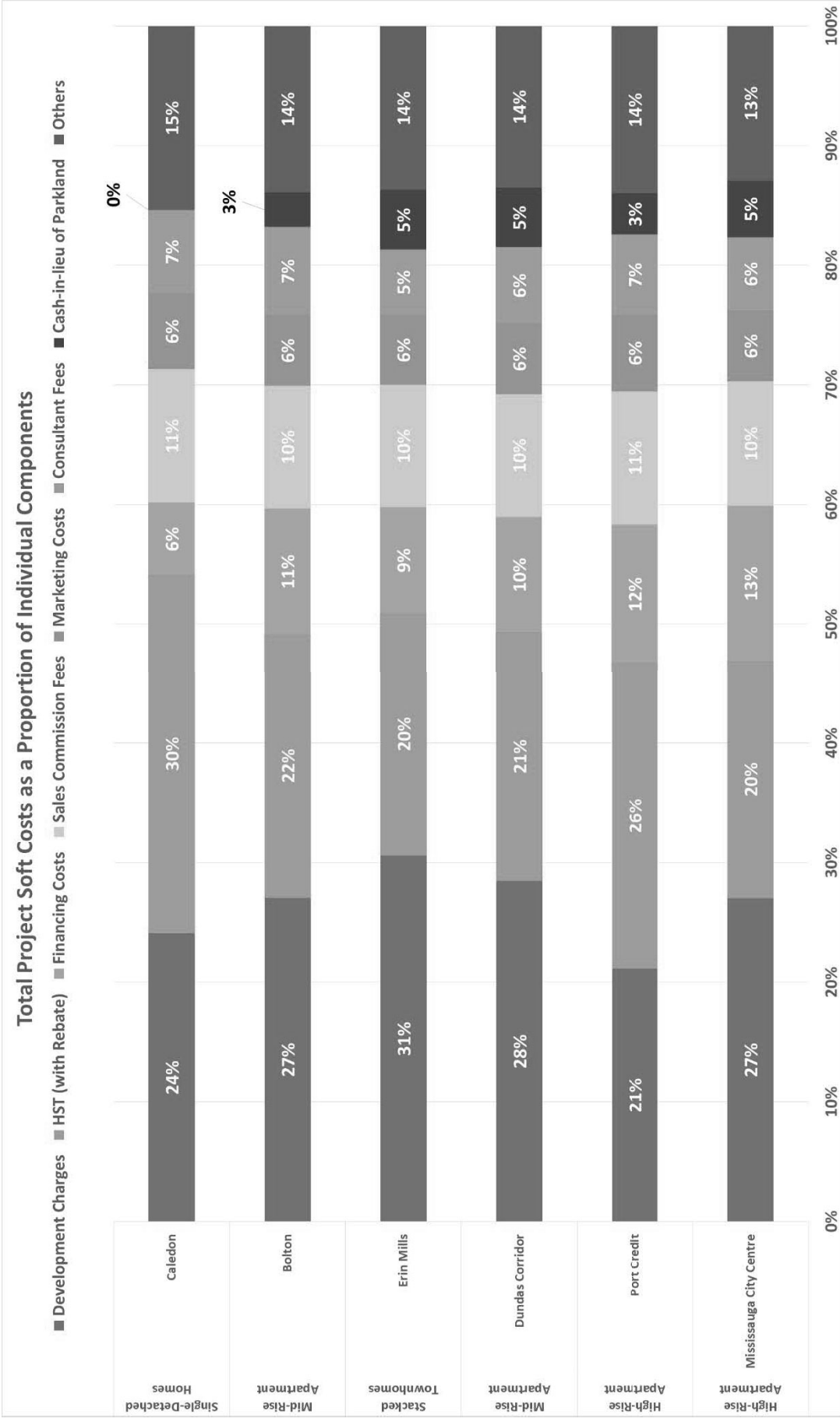

Figure 10



5.0 Discussion Questions and Conclusions

5.1 Do Development Costs Impact Housing Prices?

As discussed throughout this paper, there is a common misunderstanding that the cost of constructing new housing determines the price at which new housing can be sold, and that any new development costs introduced due to government policy can be “passed on” to the buyer through higher sale prices. Though related, the market that determines the price of a home (i.e. the market of willing buyers and sellers), is fundamentally distinct from the market that determines the cost of development.

Developers and/ or owners will charge the maximum rent or sale value for a home that the market can bear at any given time, irrespective of the cost of constructing the home in the first place. In free markets, these prices are established by the characteristics of supply and demand. Developers spend a considerable amount of effort analyzing local supply and demand conditions to determine the maximum sale price the market will absorb. This underpins the principle of the “willing buyer and seller”. As illustrated in this report, the nature of supply and demand supports different pricing levels in different areas. If costs were the major determinant of housing prices, we would observe similar pricing for housing across a region.

If the market does support an increase in the price of new homes, developers are likely to increase pricing regardless of any change in costs. This is often observed in housing projects, where the price of homes in a project increase over the sales period. The price increase is often supported by natural appreciation in the market, as well as increased demand due to a project beginning construction and therefore limiting a purchaser’s risk and the time they must wait to occupy a unit. Developers will respond to shifting market conditions and adjust pricing, regardless of any shift in construction costs. To further exemplify this economic reality, if development costs decreased by 10%, but the market supports a price increase, developers are not likely to reduce or even maintain the price of homes in their project. Rather, it is likely that they will increase the sale value of homes, as supported by the market.

Development costs do not therefore come into consideration when pricing new homes. As discussed in this paper, development costs and the developer’s required profit is subtracted from the estimated revenue of the project to determine how much the developer can afford to pay for the development site. If the sale value of homes as determined by the market does not allow a developer to meet their profit expectation and/or purchase land in the market, they are not able to build the project and will search for another development opportunity. In situations such as these, developers cannot simply increase pricing beyond what the market can support to offset development costs.

5.2 How Do Rising Development Costs Impact a Housing Project Where Land Has Already Been Purchased and/or Begun Sales?

The only exception to the economic discussion in the previous commentary is situations where developers have already purchased a development site and have presold units, but have been unable to obtain a permit before the rate increase occurs (e.g. Development Charge). In this situation, the burden of the increased fee must either be covered by the purchaser or by the developer. Most pre-construction projects “cap” the purchaser’s exposure to rising Development Charges, however some do not. In these situations, the purchaser will be responsible for covering all or a portion of the increase in Development Charges at the time of closing, which in effect increases the cost of purchase. Where the purchaser’s exposure to rate increases are capped, the increase must be shared by the developer, effectively reducing the profit associated with the project.

In situations similar to the above, a housing project could cancel if increased development costs erode a developer’s profit to the point where it no longer makes financial sense to continue. These situations are difficult for developers because they have already purchased a site, begun selling units at market value, but costs have increased significantly beyond original estimations. Rising costs can be due to construction cost increases, the discovery of physical property complications requiring greater effort/costs (e.g. geotechnical issues, archaeological discovery, etc.), rising development related charges (e.g. Development Charges, cash-in-lieu of parkland), and many others. In situations such as this, a project could cancel. There has been several high profile condominium cancellations in the GTHA over the past two years due to rising hard construction costs as well as rising soft costs.

Transition policies that phase in increased Development Charges and other development related charges are often implemented to offset this impact.

5.3 How do Development Costs Affect Overall Housing Affordability Conditions?

Development costs can affect overall housing affordability in two ways:

First, if development costs exceed the market value of housing, developers will not invest and supply will not be created. As discussed throughout this report, this is due to rising costs eroding the supportable land value of a project below the threshold where developers can acquire land in the market and make an attractive profit. If supply falls below demand, affordability of all housing supply (new and resale) will increase. Pricing will increase in this situation because there will be a larger pool of willing buyers (demand) competing for a relatively smaller number of homes (supply). However, if market pricing supports land values that well exceeds the value of other competing uses (retail, gas stations, low-density residential, etc.), there should be no impact to the viability, pricing, and supply of residential development. In these situations, developers will continue to purchase developable land in the market and charge purchasers an

amount that is supported by local supply and demand conditions. It is noted that NBLC has not assessed the impact of the proposed Development Charge rates on development viability.

Second, it is acknowledged that if development costs were lower, it would be possible for some new development to proceed at “lower” pricing. For example, there are many communities in Peel Region that currently do not support viable development. This is due to the fact that the local supply and demand conditions do not support pricing that is able to cover all development costs (including land purchase) and produce an attractive profit. It is possible that if development costs were lower, some of these projects would be able to move forward with lower relative pricing. It is important to note that the lower pricing levels are still determined by the market.

The above is a critical consideration. The economics of development are such that if the achievable home price of a project does not cover all development costs, the project will not be built. The developer will instead seek another development opportunity that displays greater evidence of viability. This practice will result in only projects located in strong market areas being able to move forward, which is generally what is observed in the market currently. This has the effect of limiting the number of more affordable housing options being supplied to the market in new development. Notwithstanding the previous point, the active supply of housing will maintain relative affordability across the entire housing market (e.g. existing homes) if demand is being satisfied through new construction.

The impact of lowering development costs to encourage a greater supply of housing at lower pricing is evaluated in the following discussion question.

5.4 Will Reduced Development Related Charges Be Passed Along to Purchasers?

In weaker market areas, where market pricing does not currently support development viability, reduced development costs can result in a project becoming viable. It is therefore possible that a greater supply of housing could be implemented if development costs were lower. However, for projects that do not require lower development costs to move forward, lowering these costs would either increase developer profits or result in increased land values. As illustrated by **Figure 3**, reducing development costs will reduce the amount that is subtracted from project revenues, which will increase the RLV (or be absorbed by profit if land can be acquired for less).

In areas where market pricing already supports a viable project, it is unlikely that developers will pass along the cost savings to purchasers because the development sector is a for-profit industry. Excluding non-profit entities and a small number of for-profit projects that specifically target an affordable market (e.g. rent to own, second mortgage programs, etc.), developers are seeking to maximize profits just like any other for-profit company. In competitive markets, available land will often have competing bids, which requires that developers be aggressive in order to acquire a development site. It is therefore likely that in strong market areas, developers will pass the cost savings through to the land value, which will allow them to bid higher for the land. As noted, if

the land is acquired for less, the savings in costs are most likely to be absorbed by the developer's profit.

Building off the above, if development costs are reduced due to decreasing development related charges, such as Development Charges, the municipality will have a funding gap for growth related infrastructure and services that would have to be funded through another avenue, which would likely be property taxes. There would also be no certainty that the reduction in development costs would be passed along to the purchaser, aside from the hope that some new housing would be developed due to the decrease in development costs.

5.5 When Have Municipalities Reduced Development Related Charges?

The waiving or deferring of Development Charges is a common incentive utilized by municipalities in Ontario for the development of affordable housing. The term "affordable housing" is explicitly defined (e.g. rent geared-to-income, 100% of CMHC average market rent, etc.) and is granted to developers that will deliver the housing at the agreed upon "below market" price. These cost savings are directly passed through to the purchaser/tenant, because developers have to build to a predetermined affordability level. Development Charge waivers can be rationalized because the provision of affordable housing is determined to be worth the cost to the municipality. However, it is important to note that this is not market housing.

Some municipalities such as Hamilton have also deployed Development Charge waivers and other incentives to encourage high-rise development in their downtown at market rates. This has nothing to do with affordability directly. Rather, the market simply does not support pricing that results in a viable project, which means that no developer would be able to build without the incentives. Hamilton is attempting to revitalize their downtown, and encourage more housing options, which is why they are offering the program. The City is now considering removing the financial incentive package due to improvements in the market and achievable pricing. Maintaining the incentives when they are no longer required, and without defined affordability targets, will result in increased developer profits and/or land values at the expense of the City.

There are many other examples of municipalities that have introduced financial incentives in Ontario to achieve various policy/planning initiatives.

5.6 Are there any implications for the City of Mississauga's "making room for the middle housing strategy"?

The City of Mississauga has prepared an affordable housing strategy designed to address housing for middle income earners (\$55,000 - \$100,000 annual household salary). The report targets the development of homes priced between \$270,000 and \$400,000 to maintain affordability for these middle income households, which currently do not exist in the market aside from condominium apartments and a limited selection of townhomes. Housing at the above noted price levels is not implemented in the current for-profit market due to the following:

- Developers can charge more for homes, as supported by the market; and
- The modest sale values noted above do not provide enough revenue to cover all development costs (hard and soft costs, land, and profit).

Consideration could therefore be given to waiving, reducing, or deferring development costs (e.g. Development Charges) in exchange for developers delivering housing at an explicitly defined and guaranteed affordability level. This would be a more appropriate response to encouraging the supply of more affordable housing types, relative to reducing development costs for all projects. The most appropriate implementation tool for providing a range of financial and non-financial tools would be through a community Improvement Plan or other similar mechanism. This approach would however result in a funding shortfall that would have to be made up by another revenue source (e.g. property taxes).

5.7 Do Development Charges Affect One Particular Housing Type More Than Others?

The impact of Development Charges on housing type is directly attributed to the revenue associated with the specific project. New single-detached homes anywhere in the GTHA are priced very high relative to other housing forms. Low-density housing types are therefore often able to absorb the higher Development Charge with less impact to the project's viability. This is also true for apartments in strong market areas, where market pricing is high relative to the Development Charge. Given that single-detached homes will often achieve a higher price than a semi-detached home, but both forms will be charged the same amount, the Development Charge will impact the lower value unit more.

On the other hand, apartments in weaker market areas will achieve lower overall project revenue but be charged the same applicable Development Charge as a building in a strong market area. This is illustrated in the case study analysis, where Development Charges account for roughly 7%-8% of total project revenue in the Port Credit and Caledon (subdivision) case study and between 9%-10% for the others. This trend is also generally observed when viewing Development Charges as a proportion of the average sale value of new homes in Mississauga and Caledon, where Development Charges account for only 5.5% of the price of a new single/demi-detached home in Mississauga and 11.5% of the price of a new single/semi-detached home in Caledon.

The impact will also depend on how many units are in the development, the size of units and qualification as a small unit by the Development Charges by-law, and when the charge is ultimately paid.

5.8 Is There a Significant Difference in Impact Depending on How Rates are Applied (e.g. per square foot, per hectare, etc.)?

Currently, Development Charges are applied on a per unit basis. From a high-level perspective, there is no evidence to suggest that the impact of Development Charges would increase or decrease if they were charged based on another metric, such as property or unit size. The Development Charge rates are determined by estimating all capital costs and other items eligible to be funded through the *Development Charges Act*. The charge is then determined by converting the total required revenue to a per capita charge, which is then converted to a variable charge by housing unit type based on unit occupancy factors (see section 2.1.1). While the application of how the charge is applied could shift, ultimately the total amount that the City is attempting to recover from new development will not change.

Currently, the City's Development Charges favour projects that incorporate larger units over more affordable smaller units. **Table 2** illustrates this finding for a hypothetical 100,000 square foot apartment building. The example highlights two scenarios, one where the average unit size is low (675 square feet) and one where the average size is larger (900 square feet). The first scenario results in more units due to the smaller unit size, where 50% will qualify as a small unit relative to only 20% in the other scenario. Due to the fact that there are more units in the first scenario, and the fact that the gap between the small unit and apartment charge is not excessive, the first scenario will pay almost 20% more in Development Charges. Of note, **Table 2** does not include the City's stormwater management charge.

Table 2

Example of Development Charges Paid for a Hypothetical Apartment		
Building Size - Gross (square feet)	100,000	
Building Size - Net (square feet)	85,000	
Development Charge - Apartments (per unit)	58,382	
Development Charge - Small Units (per unit)	40,528	
	Scenario 1	Scenario 2
Average Unit Size	675	900
Unit Yield	126	94
% Small Unit	50%	20%
Total Development Charge Paid	\$6,227,635	\$5,176,579
Development Charge Paid (per square foot)	\$62	\$52

Shifting the Development Charge to a per square foot bases can address the situation noted in **Table 2**. It would also address the low-density issue noted previously, where a smaller and less expensive semi-detached home would be charged the same as a more expensive and larger single-detached home. At the same time, many municipalities desire more family-sized units in apartment buildings, which the current Development Charge context appears to indirectly support.

It is noted that the current *Development Charges Act* does not currently allow for the residential charge to be applied by gross floor area (GFA) due to a lack of nexus between GFA and household size / demand for services.

5.9 Does the Timing of When Development Charges are Charged Have an Impact on Housing Costs?

The timing of Development Charges can have an impact on the cost of delivering housing. While most municipalities will require Development Charges to be paid at the time of building permit, some municipalities in Ontario have deferred the payment until a later date. The period of deferral varies widely, however many municipalities requiring payment upon completion of the project. Some municipalities will offer lengthier deferrals in exchange for affordable housing.

The deferral of Development Charge payment can result in cost savings for a developer, who otherwise would be required to pay the charge out of pocket or through financing at the time of building permit and therefore prior to receiving revenue from the sale of units. Deferring the payment allows a developer to avoid financing costs or out of pocket expenses, instead paying the charge with revenue received from the sale of homes. The impact of a deferral will vary, as high-rise projects with longer development time periods between building permit and project completion will benefit more than a smaller project. Similarly, many subdivision projects in Caledon are required to pay some Development Charges at the time of draft plan approval. The period between draft plan approval and project completion can be lengthy.

5.10 What Is the Impact Of Rising Cash-In-Lieu Of Parkland Charges?

As noted, cash-in-lieu of parkland is another development related charge encountered by the development industry. The charge is a measureable proportion of total project soft costs, ranging between 3%-5% of total soft costs in the Mississauga case studies evaluated. If the cash-in-lieu rate were to increase, this would be treated no differently than any other cost increasing as discussed in this report. The ultimate result of increasing soft costs would place downward pressure on land values, which depending on the specific market characteristics of the property, could negatively impact project viability. However for other projects where viability is not impacted, the increase in costs is absorbed by the land value (i.e. purchase price of land) with no impact to the sale price of homes, assuming supply and demand conditions are not significantly affected.

5.11 Overall Conclusions

Ultimately, developers and/ or owners will charge the maximum rent or sale value for a home that the market can bear at any given time, irrespective of the cost of constructing the home in the first place. If the maximum price supported by the market does not produce enough revenue to cover all development costs (including the purchase of land and an attractive profit), the developer will not build the project.

If development costs increase, which can be due to a variety of factors, developers will discount the amount they pay for a development site. The land value is negatively impacted because other elements of the equation (**Figure 3**) are generally fixed: the sale price of homes cannot exceed what the market of willing buyers are willing to pay and a developer is generally unwilling to reduce their required profit expectation. Understanding that developers are already charging the maximum the market will support (and are likely to increase pricing if the market is supportive regardless of any shift in development costs) clearly illustrates that the only flexible variable in development economics is the purchase price of a development site.

In communities where market pricing supports land values that well exceeds the value of other competing uses (retail, gas stations, low-density residential, etc.), there should be no impact to the viability, pricing, and supply of residential development. In these situations, developers will continue to purchase developable land in the market and charge purchasers an amount that is supported by local supply and demand conditions.

However, if the land value of a residential development site is reduced below the value of other competing uses or below the expectation of a land owner, a developer will not be able to purchase the property and would not be able to build the project. If the viability of residential development is impacted on a large scale, the supply of housing will be reduced as developers will be unable to build new housing. If supply does not meet demand, the price of both new and existing homes will increase, which is a function of basic housing economics (i.e. a large pool of buyers competing for a small amount of space).

The case studies evaluated in this report illustrate this market commentary. Some of the case studies had strong supporting land values such as the high-rise buildings in Mississauga City Centre and Port Credit, Stacked Townhomes in Mississauga, and single-detached homes in Caledon. As such, much of the development occurring in Mississauga and Caledon is dominated by these housing forms. While this report has not evaluated the impacts of the proposed Development Charge increase in any significant detail, it is possible that these types of projects will be able to absorb moderate cost increases without a major impact to project viability (subject to the magnitude of cost increase and other considerations mentioned in this report).

On the other hand, the mid-rise apartments in Bolton and on Mississauga's Dundas Corridor produce much weaker land values and display weaker evidence of project viability. This is not surprising given the fact that this built-form is a modest component of Mississauga's development activity and only one apartment project has ever occurred in Bolton.

To encourage a greater supply of housing targeted to low and middle-income households, such as apartments in modest market areas, consideration can be given to waiving, reducing, or deferring development costs (e.g. Development Charges) in exchange for developers delivering housing at an explicitly defined affordability level through a Community Improvement Plan or other similar mechanism. Reducing development related charges for all development projects is not

recommended as projects that do not require the incentives would absorb the cost savings through increased profit and/or by paying more for a development site. There would be no guarantee that the savings in costs would be passed on to purchasers and the City would lose Development Charge revenue that would have to be funded through another source such as property taxes.

Appendix A: Case Study Built Form Analysis

Case Study #1: High-Rise Apartment in Mississauga City Centre

Mississauga City Centre serves as Mississauga's downtown and is one of the city's most vibrant and urban communities. The area offers a variety of retail services at Square One Shopping Centre as well as an art gallery, performing arts centre, post-secondary institution and recreational centres. City Centre also provides access to local and regional transit via the Square One Bus Terminal and the Cooksville GO Train station. In addition to the abundance of services and amenities, City Centre also hosts community festivals and displays of public art at Celebration Square, which contributes to the area's desirability.

Over the past two decades, Mississauga City Centre has experienced a proliferation of high-rise residential activity primarily in the form of condominium apartments, which contrasts with the existing stock of older purpose-built rental apartment buildings and ground-oriented housing in the surrounding area. The majority of the new high-rise development activity is predominately concentrated around Burnhamthorpe Road West near both the Hurontario Street / Confederation Parkway intersections.

Many of the recent high-rise projects in City Centre tend to have large podiums and are located on large parcels of land with heights exceeding 40 storeys (e.g. Amacon Blocks, Daniels Blocks, M City property). Looking forward, these large properties located away from Hurontario will be in short in supply. We have therefore examined the Edge Towers development as a representative project due to the smaller floor plates and location near Hurontario Street.

Edge Towers is a multi-phase development by Solmar Development Corp. located at the southwest corner of Hurontario Street and Elm Drive. The first tower opened in October 2017 and is currently in pre-construction. It will have a 3-storey podium for a total of 35 storeys with 323 units. The podium will have a floor plate of 1,118 m² with a tower floor plate of 750 m² for a total gross floor area ("GFA") of 24,450 m².

The second tower opened in May 2018 and is also in pre-construction. It will also have a 3-storey podium with an overall height of 40 storeys with 422 units. Similar to the first tower, the second tower will have a floor plate of 1,118 m² with a tower floor plate of 750 m² for a GFA of 28,500 m². There is a proposed third tower expected to open at a future date that will have a podium floor plate of 1,197 m² and tower floor plate of 750 m² with a GFA of 36,000 m². The overall floor

Edge Towers 1 & 2



space index (“FSI”) of the development is expected to be 6.9. While newer projects such as M City are proposing over 700 units per building, we believe the building scale of Edge to be a more typical scale to base the prototype on.

The first two towers have similar suite mixes, with approximately 55% of the units being two-bedroom or two-bedroom plus den and 45% being one-bedroom or one-bedroom plus den. The average unit size across both projects is approximately 660 square feet. In addition to the surveyed comparable precedents, NBLC reviewed the January 2013 Downtown Core Built Form Standards (the “Standards”) to determine appropriate setbacks, tower step backs and tower floorplates.

NBLC has assumed the prototype for the Mississauga City Centre to be a 35-storey tower atop a 3-storey podium. Following the recommendations outlined in the Standards and the requirements of By-law 0225-2007, NBLC has assumed that the podium is setback 3 metres from the property line. Furthermore, as outlined in the Standards, a tower floor plate of 750 m² has been assumed and a tower step back of 3 metres to all podium edges. Based on the provided step backs and similar to the Edge Tower developments, the podium has a floor plate of 1,124 m². The ground floor height is assumed to be 4.5 metres for commercial uses and all residential floors have a floor height of 3.5 metres, for a total building height of 123.5 metres.

To arrive at a lot size, NBLC has assumed the FSI of the prototype would be 6.9, which is the overall FSI for the Edge Tower development. Based on an overall GFA of 27,372 m², the site area for the prototype is 3,965 m² (.98 acres). NBLC has assumed an average unit size of 645 ft². The smaller unit size is based upon the observed trend within the Edge towers and other projects in the area. It is assumed that no units will be located on the ground floor and the building will achieve a net to gross efficiency of 85%, therefore the unit yield is 372 units. It is assumed that there will be a fairly even split between 1-bedrooms and 2-bedroom unit types at 45% and 55% respectively. Parking is assumed to be underground.

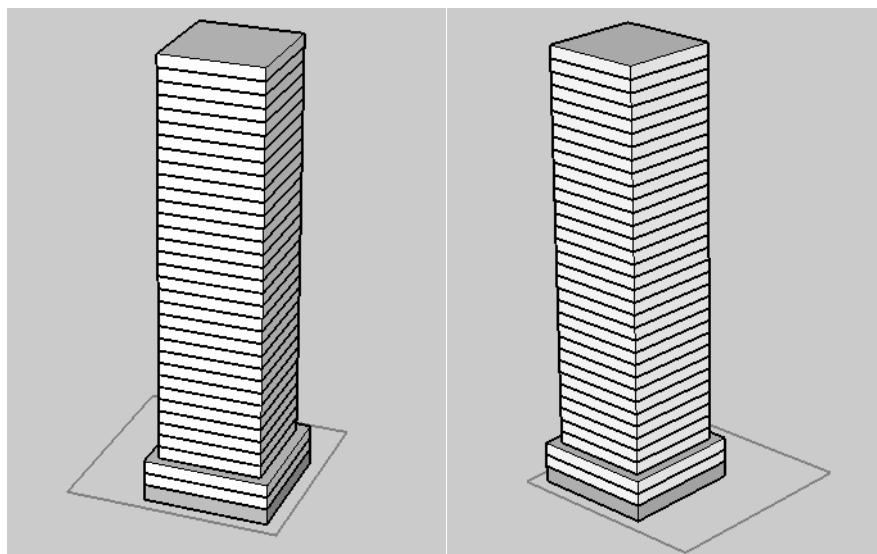

Development Statistics for Prototype - Mississauga City Centre								
Floor	# Floors	Height (m)	Avg. Floor Plate Size (m ²)	Average Unit Size (sf)	# of Units	Total GFA (m ²)	Lot Area (m ²)	FSI
Precedents								
Edge Tower 1	35	-	937	690	323	24,450	3,543	6.90
Edge Tower 2	40	-	937	641	422	28,500	4,130	6.90
Totals/Average:	38	-	937	660	373	26,475	3,837	6.90
Prototype								
1	1	4.50	1,124	-	-	1,124	-	-
2-3	2	7	1,124	645	32	2,248	-	-
4-35	32	112	750	645	340	24,000	-	-
Totals:	35	123.5	999	645	372	27,372	3,965	6.90

Source: N. Barry Lyon Consultants Limited

Case Study #2: High-Rise Apartment in Port Credit

Port Credit is a highly desirable neighbourhood along Mississauga's waterfront with high real estate values. The area offers a broad range of commercial and retail services along Lakeshore Road East with access to regional GO Rail service and the proposed Hurontario LRT, which all contribute to Port Credit's attractiveness. The area has experienced recent growth in higher density formats with the development of high-rise and mid-rise apartment buildings near the Hurontario Street and Lakeshore Road East intersection, including the 185-unit 'Port Credit Village' townhouse development on the southeast corner.

There are two new condominium projects in Port Credit. The first project, Tanu Condos by Edenshaw Developments, opened in October 2018 and is currently the only actively marketing high-rise project in Port Credit. The project is currently in pre-construction and is expected to be 15 storeys with 192 residential units. The site is located mid-block on Park Street East with a lot area of 3,072 m². The building will have an approximate gross floor area ("GFA") of 19,216 m² for an overall floor space index ("FSI") of 6.26.

The second project, Nola Condos by Fram Building Group and Slokker, opened in May 2016 and is the most recently sold out high-rise project in Port Credit. The project is currently under construction and will be 15 storeys in height with 70 residential units, including two semi-detached homes. The site is located on the southeast corner of High Street East and Ann Street with a lot area of 1,924 m². The lot area of the apartment building, excluding the area for the semi-detached homes, is approximately 1,532 m². The building will have a GFA of 8,231 m² with a 5.37 FSI.

Both of these projects have similar suite mixes, with approximately 60% of units being two-bedroom or larger and 40% being one-bedroom or bachelor. The average unit size across both projects was approximately 950 ft², which is considered large relative to many other market areas in Mississauga and the GTHA for high-rise condominium buildings. These projects are likely targeting move-down and senior purchasers.

In addition to the recent precedents in the local market area, NBLC reviewed the November 2014 Port Credit Built Form Guide (the "Guide") to determine appropriate lot sizes, overall height, building design and maximum tower floorplates. The Guide recommends that a mid-block site

Tanu Condos (Top) & Nola Condos (Bottom)



should be a minimum of 45 metres by 45 metres (2,025 m²), whereas a corner block site should be at least 40 metres by 45 metres (1,800 m²).

Based on the precedents and the Guide, and the limited availability of corner lots, NBLC believes that a 15-storey mid-block apartment building would be appropriate in Port Credit as a representative prototype. Notwithstanding the recommended minimum site area of 2,025 m² for a mid-block property, the precedents provided a slightly smaller site area; therefore, NBLC has assumed a site area of 1,925 m² (.48 acres), which is consistent with Nola Condos. Consistent with the Guide and the precedents, the prototype is setback 3-metres from the front and side property lines with a 23-metre depth from floors 1 to 10 to allow for maximum efficiency. To allow for a mixture of uses on the ground floor, the height of the first floor is 4.5 metres, while the remaining floors are 3 metres in height. To minimize potential adverse impacts to the surrounding neighbourhood, the building steps back 3 metres at floors 11 and 14. The step backs and floors at which the building steps back are similar to those seen in both Tanu Condos and Nola Condos.

Following the recommendations from the Guide, the prototype has a tower floor plate between 540 m² and 730 m². The overall GFA of the prototype is approximately 10,288 m², giving an FSI of 5.37 times the site area. It has been assumed that the prototype will have a similar suite mix to the precedents, with 40% of units being 1-bedroom types, 55% 2-bedroom types and 5% three-bedrooms. We therefore assume an average unit size of approximately 900 ft², which yields 97 total units, assuming no units are on the bottom floor and the building achieves a net to gross efficiency of 85%. Parking is assumed to be underground.

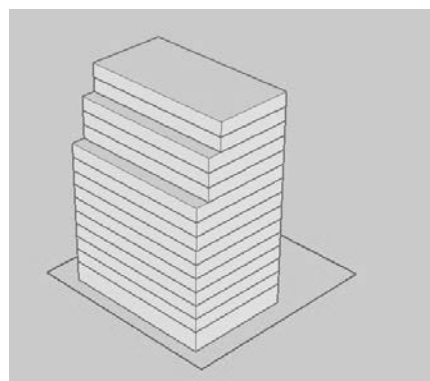

Development Statistics for Prototype 1 - Port Credit								
Floor	# Floors	Height (m)	Avg. Floor Plate Size (m ²)	Average Unit Size (sf)	# of Units	Total GFA (m ²)	Lot Area (m ²)	FSI
Precedents								
Tanu	15	-	1,227	897	192	19,216	3,072	6.26
Nola	15	-	6,413	1,104	70	8,231	1,924	4.28
Totals:	15	-	3,820	952	131	13,724	2,498	5.27
Prototype								
1	1	4.5	730	-	-	730	-	-
2-10	9	27	730	955	63	6,570	-	-

11-13	3	9	636	955	18	1,908	-	-
14-15	2	6	540	955	10	1,080	-	-
Totals:	15	47	659	900	97	10,288	1,925	5.34

Source: N. Barry Lyon Consultants Limited

Case Study #3: Mid-Rise Apartment Along the Dundas Corridor

The Dundas Street Corridor is a major route within the City of Mississauga stretching almost 20 km from Oakville in the west to Etobicoke in the east. Although there are a variety of retail and commercial services along the Dundas Corridor, there is currently limited market appeal for higher density housing. The few mid-rise apartments that have been developed are mainly concentrated near Cawthra Road or Erin Mills Parkway. However, the City has initiated the Dundas Connects master plan to create a planning framework that is intended to encourage intensification and convert the corridor into a mixed-use, transit-oriented route supported with bus rapid transit.

The EV Rolaye Condos by YYZed Project Management and Nurreal Capital is the only actively marketing project along the Dundas Street Corridor. The project opened in November 2016 and is currently in pre-construction. The building is proposed at 7 storeys with 99 units and is located in the Erindale Village neighbourhood. The building proposes a gross floor area (“GFA”) of 12,415 m² with a floor space index (“FSI”) of 3.7 on a site area of 3,480 m² (0.86 acre). The project has a suite mix of approximately 60% two-bedroom or larger units and 40% one-bedroom and one-bedroom plus den units, with an average unit size of 1,183 ft². It is important to note that this project is still in the development approvals process and has not yet been approved.

Given the lack of new mid-rise development along Dundas, NBLC also examined two older mid-rise buildings to help inform a representative built form prototype. The first building, Park 570 by Vandyk Properties Inc., opened in 2010 and is located near the Dundas Street East and Cawthra Road intersection. The building is 4 storeys in height with 180 units. It is located on 11,153 m² (2.8 acre) property with a GFA of 18,816 m² for an overall FSI of 1.69. In regard to suite mix, approximately 55% two-bedroom and two-bedroom plus den units and 45% are one-bedroom and one-bedroom plus den units, with an average unit size of 1,003 ft².

The second building, Windows on the Green by Vandyk Properties Inc. (3170 Erin Mills Parkway), opened in 2012 and is located just north of the Dundas Street West along Erin Mills

Park 570 (Top) & Windows on the Green (Bottom)



Parkway. The building is also 4 storeys in height with 150 units. Similar to the Park 570 building, it is located on a large property with a site area of 10,967 m² (2.7 acres) and an overall GFA of 15,904 m² for an overall FSI of 1.69. This building has a higher proportion of one-bedroom and one-bedroom plus den units (approx. 60%) than Park 570 with remaining 40% being two-bedroom or larger. The average unit size is slightly smaller than the other projects with an average of 945 ft².

After completing a review of the available lots along the Dundas corridor, NBLC has assumed a rectangle lot with an overall area of 5,500 m² (1.4 acre). Based on the lot shape, as well as the vision for Dundas Connects, NBLC believes that a long building (80 metres) fronting onto Dundas is appropriate. Consistent with the Official Plan, the prototype is setback 5-metres from the property line and has allowed for a driveway and some parking to be located above ground to the rear of the building. To allow for maximum efficiency, the depth of the base of the prototype is 23 metres. The ground floor has a height of 4.5 metres with subsequent floors having a height of 3 metres, for an overall building height of 17.5 metres.

In order to arrive at a floor plate, NBLC assumed a similar size floor plates as the buildings in the Dundas / Cawthra area according to the Dundas Connects 3-D mapping illustration. The podium of the building has a floor plate of 1,863 m², and an overall GFA of 5,590m². Above the 3-storey podium, the prototype steps back 3 metres on each side leading to a floor plate of 1,368 m². The overall GFA of the prototype is 8,325 m². The prototype has an FSI of 1.51, which is approximately the average of the two approved projects along Dundas.

Based on the estimated average unit size of 8000 ft², the prototype yields 95 units. It has been assumed that the prototype will have a similar suite mix to the precedents, with 50% of units being 1-bedroom, 45% being two-bedrooms and 5% of units being three-bedrooms. Parking is assumed to be located above ground to the rear of the building, as well as below ground.

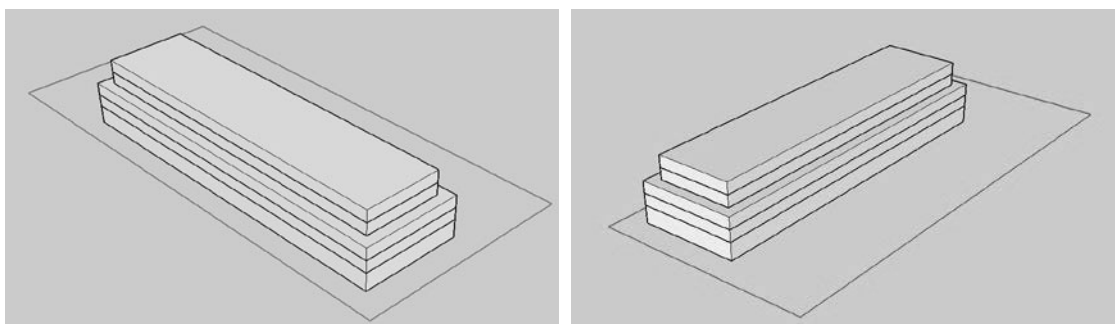

Development Statistics for Prototype 1 - Dundas Corridor								
Floor	# Floors	Height (m)	Avg. Floor Plate Size (m2)	Average Unit Size (sf)	# of Units	Total GFA (m2)	Lot Area (m2)	FSI
Precedents								
EV Royale	8	-	-	1,183	96	12,415	3,480	3.57

Windows on the Green	4	-	369	945	154	15,904	10,967	1.45
Park 570	4	-	437	1,003	180	18,816	11,153	1.69
Totals:	5	-	403	951	143	15,712	8,533	2.23
Prototype								
1	1	4.5	1,863	950	12	1,863	-	-
2-3	2	6	1,863	950	36	3,726	-	-
4-5	2	6	1,368	950	26	2,736	-	-
Totals:	5	17	1,698	800	95	8,325	5,500	1.51
<i>Source: N. Barry Lyon Consultants Limited</i>								

Case Study #4: Stacked Townhome in Erin Mills

The majority of actively marketing stacked townhouse projects in Mississauga are large developments consisting of over 100 units that require large properties and therefore not considered appropriate as a representative built form likely to be seen on a significant scale looking forward. Given the lack of recent precedents for infill stacked townhomes in Mississauga, NBLC surveyed two recently approved infill projects located near the Mississauga border within the City of Toronto.

The first project is located at 62 Long Branch Avenue on a 2,114 m² (0.52 acre) lot and proposes two blocks of three-storey stacked townhomes containing a total of 28 units. The proposed gross floor area (“GFA”) is approximately 3,300 m² for a floor space index (“FSI”) of 1.56 times the lot area. The project will consist of only two-bedroom units with an average unit size of 1,270 ft². Parking will be provided in an underground garage.

The second project is located at 400 East Mall and proposes three blocks of four-storey stacked townhomes containing 62 units. The proposed GFA is 4,709 m² with an FSI of 1.02 times the lot area. The project proposes a suite mix of approximately 65% one-bedroom units and 35% two-bedroom units. Parking will also be provided in a single level underground garage.

In addition to the surveyed precedents, NBLC reviewed the Draft Urban Design Guidelines for Back to Back and Stacked Townhouses (the “Guidelines”) as well as Zoning By-law 0225-2007 (the “by-law”).

Based upon the precedents, NBLC has assumed that the prototype will be located on a square lot with an overall area of approximately 3,400 m² (0.84 acre). The two precedents found in Toronto have an average FSI of 1.29 times the property size, however the by-law has outlined a maximum FSI of

62 Long Branch Ave (Top) & 400 East Mall (Bottom)



0.9 times the site area for stacked townhouses; therefore, this is the density that NBLC has assumed.

The prototype has a front yard setback of 5.5 metres and is consistent with the Guidelines recommendation of 4.5 metres from the side property lines. The block length is approximately 34 metres, which is below the Guide's recommendation of a maximum block length of 41 metres. The two blocks are setback 15 metres from one another, consistent with the Guidelines. Based upon the stacked townhouse projects marketing in Mississauga, NBLC has assumed that the prototype will be 3-storeys in height, for an overall height of 9 metres, which complies with the maximum height of 10 metres set out in the by-law.

Based upon the assumed lot size and the maximum allowable FSI, NBLC has assumed an overall GFA of 3,060 m², which results in an average floor plate of 510 m². According to the Guidelines, the minimum unit width is 4.5 metres, therefore the depth of the prototype is 14.85 metres. Based upon an average unit size of 850 ft², the unit yield is 39 units. Based upon the precedents in Toronto, as well as the active marketing projects, NBLC has assumed a suite mix of 42% 1-bedrooms, 55% two-bedrooms and 3% 3-bedrooms. Parking is assumed to be below grade with some surface spaces. These are single-loaded stacked townhomes.

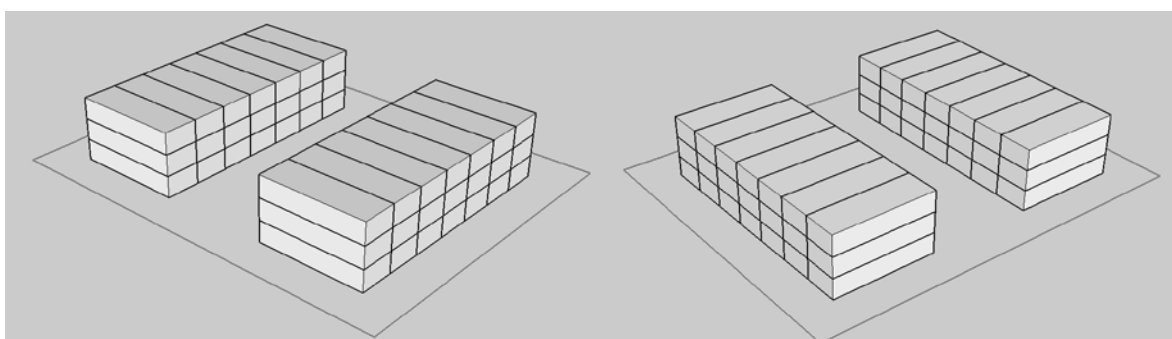

Development Statistics for Prototype - Stacked Townhouse								
Floor	# Floors	Height (m)	Avg. Floor Plate Size (m ²)	Average Unit Size (sf)	# of Units	Total GFA (m ²)	Lot Area (m ²)	FSI
Precedents								
62 Long Branch Ave.	3	11.7	555	1,270	28	3,301	2,114	1.56
400 East Mall	4	14	514	637	62	4,709	4,600	1.02
Totals:	4	13	535	954	45	4,005	3,357	1.29
Prototype								
Block 1	3	9	510	955	17	1,530	-	-
Block 2	3	9	510	955	17	1,530	-	-
Totals:	6	9	510	850	39	3,060	3,400	0.90
<i>Source: N. Barry Lyon Consultants Limited</i>								

Case Study #5: Mid-Rise Apartment in Bolton

Bolton is Caledon's most populous community with a historic downtown core that has a full complement of local retailers and services with access to several nearby hiking trails and recreational opportunities. The area has a small-town charm while still being in close proximity to larger urban areas. Bolton's existing residential development is comprised predominantly of single-detached homes on the fringe of the downtown core. In regard to higher density formats, there has only been one condominium apartment building developed in Bolton - River's Edge by Armour Heights Developments.

River's Edge is an L-shaped 5-storey, 72-unit adult lifestyle building. It opened in 2007 and is located along the Humber River in the downtown core. The site area is 6,879 m² (1.7 acre) with a gross floor area ("GFA") of 8,879 m² for an overall floor space index ("FSI") of 1.29. About 75% of the building consists of two-bedroom and two-bedroom plus den units with the remaining 25% being one-bedroom and one-bedroom plus den units. The average unit size is approximately 1,128 ft², which is significantly larger relative to many other market areas in Peel Region and the GTHA for mid-rise condominium buildings.

In addition, NBLC examined a development proposal for a new 5-storey, 73-unit residential condominium apartment building located at 50 Ann Street, immediately adjacent to the River's Edge building. The site area is 3,616 m² (0.9 acre) with a proposed gross floor area of 7,001 m² for an overall FSI of 1.94. This proposal is still in the development approvals process and is not yet marketing, so there is currently no available information regarding suite mix and unit sizing.

Due to the scarcity of higher density development in Bolton, NBLC has largely based the prototype on the proposed 50 Ann Street development. Additionally, NBLC has consulted the Town of Caledon Official Plan Section 5.10.4.5 "Bolton Settlement Area" to determine the appropriate built form.

Because both precedents found in Bolton are on adjacent blocks of varying size, NBLC has assumed that the prototype will be built on a similar shaped (rectangle) lot of approximately 4,858 m² (1.2 acre). The prototype has a ground floor height of 4 metres with all other floors having a height of 3.5 metres, for an overall building height of 17 metres. The prototype is a 5-storey building with a floor plate of 1,584 m², for an overall GFA of 7,920 m². Based on a property size of 4,858, the prototype has an overall FSI of 1.63.

River's Edge (Top) & 50 Ann Street (Bottom)



NBLC has assumed an average unit size of 1,000 ft², which is the estimated average of the two precedents. Based on the prototype's GFA and the assumed unit size, the prototype has 72 units. Similar to River's Edge and the proposed 50 Ann Street, there will be a mix of surface and underground parking.

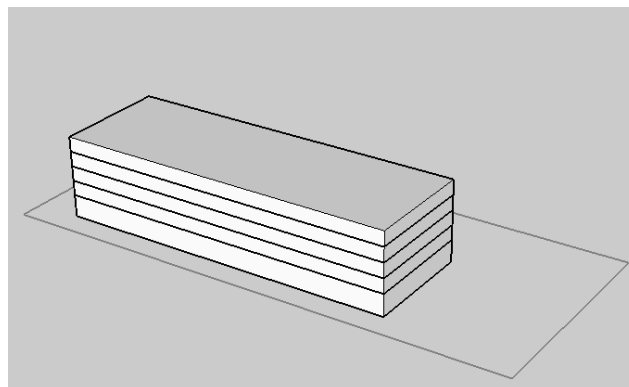

Development Statistics for Prototype - Bolton								
Floor	# Floors	Height (m)	Avg. Floor Plate Size (m2)	Average Unit Size (sf)	# of Units	Total GFA (m2)	Lot Area (m2)	FSI
Precedents								
50 Ann	5	20	1,400	877	73	7,001	3,617	1.94
River's Edge	5	20	1,776	1,128	72	8,879	6,880	1.29
Totals:	5	20	1,588	1,002	73	7,940	5,248	1.61
Prototype								
1	1	3.9	1,584	1,000	14	1,584	-	-
2-5	4	13.1	1,584	1,000	58	6,336	-	-
Totals:	5	17	1,584	1,000	72	7,920	4,858	1.63

Source: N. Barry Lyon Consultants Limited

Case Study #6 Single-Detaches Homes in Caledon

The Town of Caledon has experienced strong low-density residential housing development through greenfield subdivisions over the past decade. Low-density housing starts in the Town averaged just over 465 units per year between 2010 and 2014, which has increased to an annual average of nearly 610 new units since this time. At the time of our survey, there were seven actively marketing projects in the Town currently selling single-detached homes. In total, there were 1,236 total single-detached lots within these projects, of which 90% were sold, meaning there were only 125 units available for sale. It is noted that most of these projects have a combination of single and semi-detached homes as well as townhomes available for sale.

The Mayfield West area had the largest concentration of actively marketing single-detached projects in Caledon. Three of the seven projects were located in this area, totaling 892 lots (about 70% of the total lots). While there are a wide variety of single-detached homes available for sale

in the market, the most popular offering by far is a 36 foot lot ranging in size between 2,300 and 2,950 square feet.

We have therefore assumed a 2,650 square foot single-detached home on a 36 foot lot as the prototype. The subdivision will contain 40 total units and will require 2.0 hectares of land at a density of 20 units per hectare. The project will require on-site parkland dedication of 5% of the lot area and approximately 275 metres of local roads (assumes each home is 36 feet * 40 units = 1,440 feet; assume 2 units on each side of the street and a 25% gross up = 900 feet or 275 metres).

Appendix B: Market Data

Surveyed Actively Marketing (New) Condominium Apartment Projects in Mississauga City Centre As of December 31, 2018														
Map ID	Project Name / Developer	Open Date	Con. Status ¹	Storeys	Total Units	Total Units Released	Total Sales	% Sold	Size Range (sf)	Price Range	Avg. \$PSF ²		Avg. Sales/Mo. ³ Overall	
											Orig.	Curr.		70%
1	Keystone - West Tower <i>Kaneff</i>	Nov-18	Pre	23	202	202	71	35%	601 - 1,117	\$425,990 - \$745,990	\$715	\$716	36.6 2	
2	M3 - M City Condominiums <i>Rogers Real Estate Development Limited and Urban Cap</i>	Oct-18	Pre	81	864	680	449	52%	522 - 1,006	\$420,400 - \$798,900	\$792	\$787	184.6 2	
3	Edge Towers 2 <i>Solmar Development Corp.</i>	May-18	Pre	40	422	308	157	37%	492 - 721	\$434,900 - \$616,900	\$773	\$874	21.4 7	
4	Edge Towers <i>Solmar Development Corp.</i>	Oct-17	Pre	35	323	323	264	82%	465 - 1,247	\$390,900 - \$1,049,900	\$639	\$844	34.6 15	
5	Daniel's City Centre - Wesley Tower <i>Daniel's Corporation</i>	Aug-17	UC	43	503	503	452	90%	458 - 996	\$405,900 - \$709,900	\$602	\$768	28.1 16	
6	M2 - M City Condominiums <i>Rogers Real Estate Development Limited and Urban Cap</i>	Apr-17	UC	61	797	797	746	94%	446 - 1,310	\$259,900 - \$867,900	\$630	\$660	271.8 20	
7	M City <i>Rogers Real Estate Development Limited and Urban Cap</i>	Mar-17	UC	60	781	781	748	96%	402 - 1,282	\$245,400 - \$867,900	\$610	\$664	550.6 21	
8	Grand Mirage <i>Conservatory Group</i>	Feb-16	UC	22	344	344	328	95%	583 - 950	\$459,900 - \$663,900	\$472	\$728	17.2 15	
9	Pinnacle Grand Park 2 <i>Pinnacle International</i>	Oct-12	SI	48	461	461	456	99%	590 - 2,312	\$398,900 - \$1,399,900	\$425	\$635	7.2 47	
Total / Average / Range: 9 Projects				46	4,697	4,399	3,671	78%	402 - 2,312	\$245,400 - \$1,399,900	\$629	\$791	32.2	19.0

1. Construction Status: "Pre" = pre construction, "UC" = under construction, "SI" = Standing Inventory. 2. Average dollar per square foot: original value is based on total inventory at the time of the project launch, current value is based on remaining inventory. 3. Average sales per month (absorption rate): the top number represents the number of sales per month, the bottom number represents the number of months. 70% rate is calculated from the project opening date until at least 70% sold, overall rate is calculated from the project opening date to the current date (December 31, 2018).
Source: Altus Group / RealNet

Map 1: Location of Projects in Mississauga City Centre

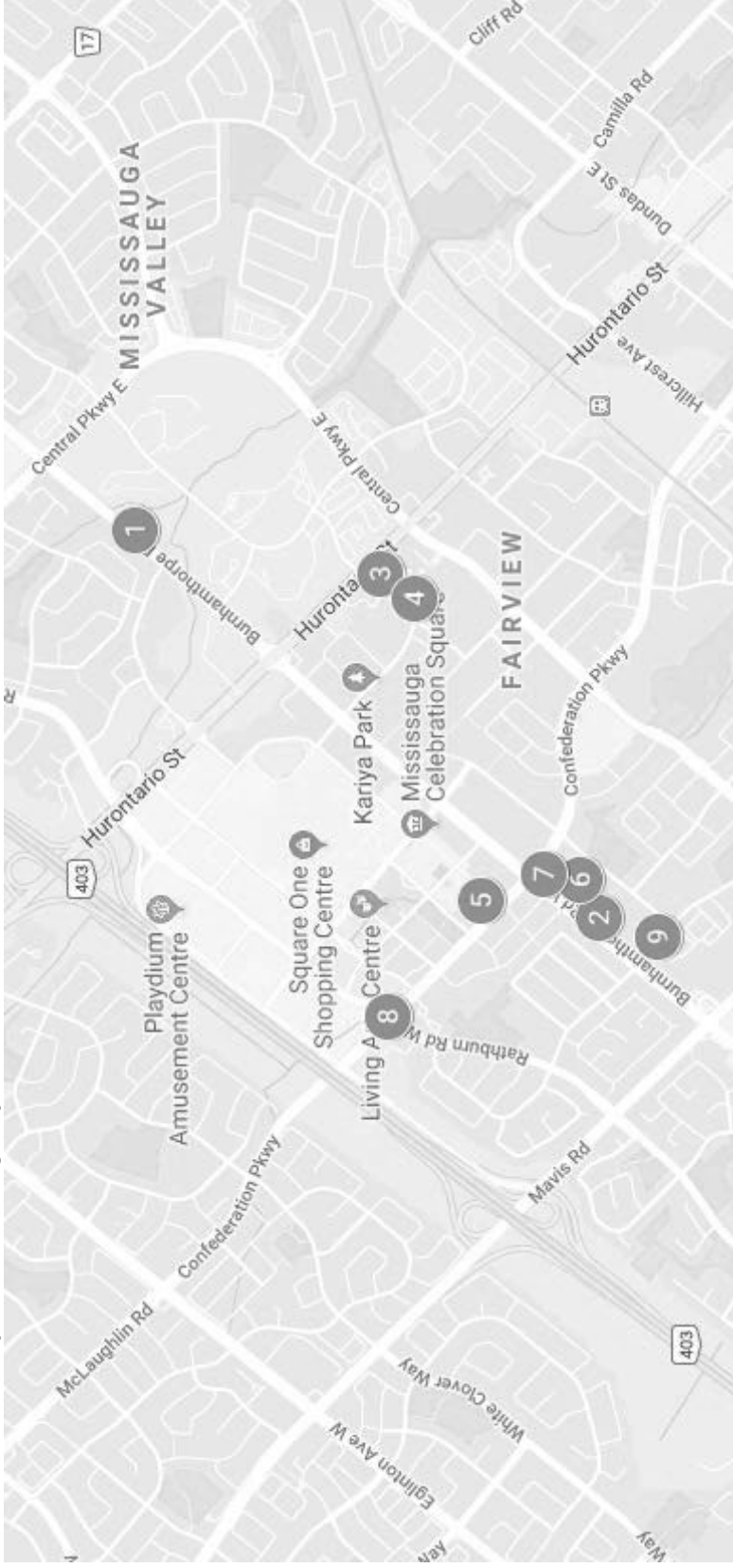

Surveyed Actively Marketing (New) Condominium Apartment Projects in Port Credit														
As of December 31, 2018														
Map ID	Project Name / Developer	Open Date	Con. Status ¹	Storeys	Total Units	Total Units Released	Total Sales	% Sold	Size Range (sf)	Price Range	Avg. \$PSF ²		Avg. Sales/Mo. ³	
											Orig.	Curr.	70%	Overall
1	Tanu Edenshaw Developments	Oct-18	Pre	15	204	192	145	71%	626 - 1,500	\$546,900 - \$1,357,900	\$878	\$877	63.9	63.9
Total / Average / Range: 1 Projects				15	204	192	145	71%	626 - 1,500	\$546,900 - \$1,357,900	\$878	\$877	63.9	63.9

1. Construction Status: "Pre" = pre construction, "UC" = under construction 2. Average dollar per square foot: original value is based on total inventory at the time of the project launch, current value is based on remaining inventory. 3. Average sales per month (absorption rate): the top number represents the number of sales per month, the bottom number represents the number of months. 70% rate is calculated from the project opening date until at least 70% sold, overall rate is calculated from the project opening date to the current date (December 31, 2018).
Source: Altus Group / RealNet

Recently Sold Out Condominium Apartment Projects in Port Credit														
As of December 31, 2018														
Map ID	Project Name / Developer	Open Date	Con. Status ¹	Storeys	Total Units	Total Units Released	Total Sales	% Sold	Size Range (sf)	Price Range	Avg. \$PSF ²		Avg. Sales/Mo. ³	
											Orig.	Curr.	70%	Overall
2	Nola Fram Building Group and Slokker	May-16	UC	15	70	70	70	100%	510 - 2,240	\$276,900 - \$1,729,900	\$599	\$775	50.7	5.7
Total / Average / Range: 1 Projects				15	70	70	70	100%	510 - 2,240	\$276,900 - \$1,729,900	\$599	\$775	50.7	5.7

1. Construction Status: "Pre" = pre construction, "UC" = under construction 2. Average dollar per square foot: original value is based on total inventory at the time of the project launch, current value is based on remaining inventory. 3. Average sales per month (absorption rate): the top number represents the number of sales per month, the bottom number represents the number of months. 70% rate is calculated from the project opening date until at least 70% sold, overall rate is calculated from the project opening date to the current date (December 31, 2018).
Source: Altus Group / RealNet

Map 2: Location of Projects in Port Credit

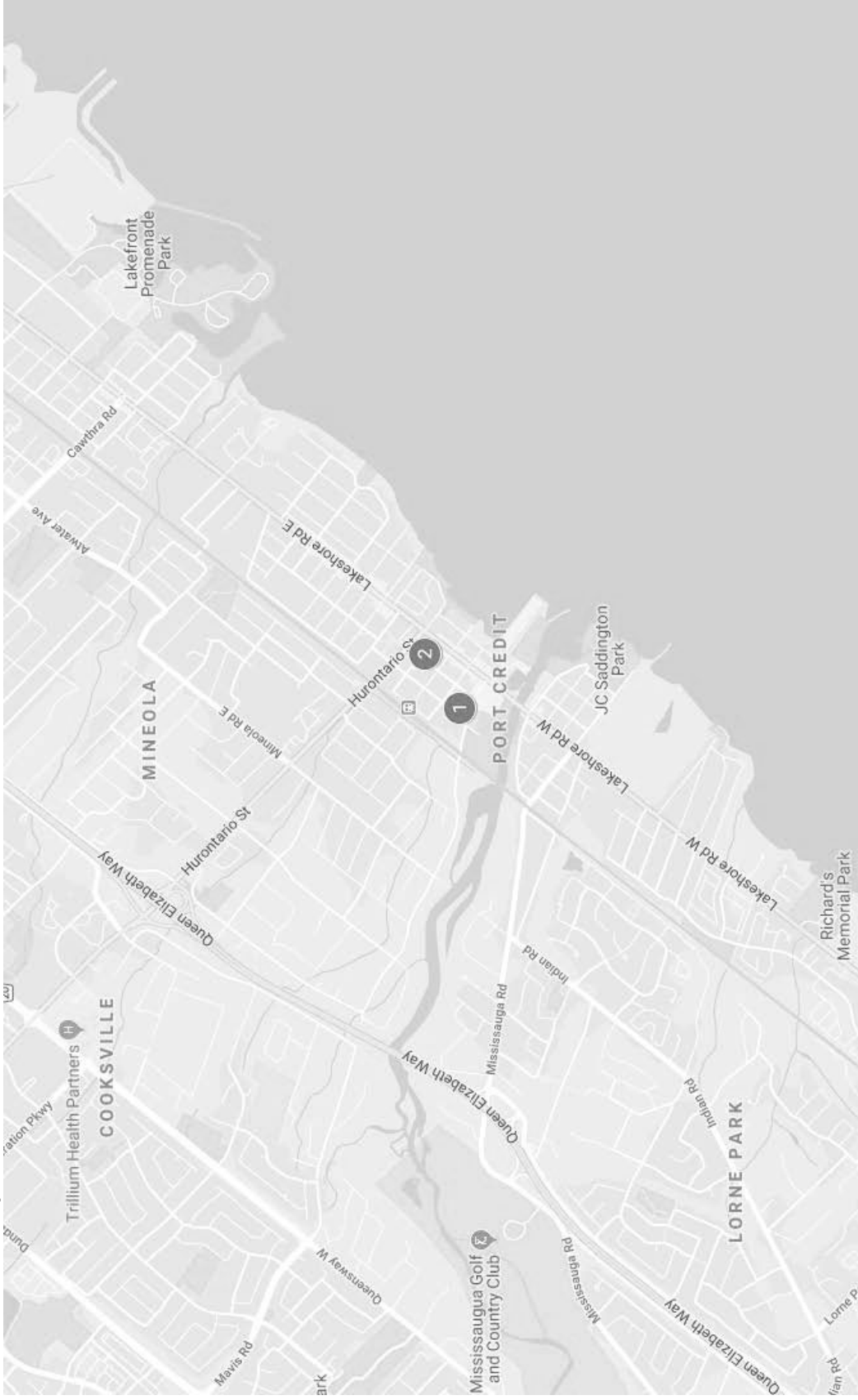

Surveyed Actively Marketing (New) Condominium Apartment Projects along the Dundas Corridor

As of December 31, 2018

Map ID	Project Name / Developer	Open Date	Con. Status ¹	Stores	Total Units Released	Total Sales	% Sold	Size Range (sf)	Price Range	Avg. \$PSF ²		Avg. Sales/Mo. ³
										Org.	Curr.	
1	EV Royale	Nov-16	Pre	7	99	85	86%	616 - 2,059	\$435,900 - \$1,273,900	\$666	\$683	30.4
Total / Average / Range: 1 Projects				7	99	85	86%	616 - 2,059	\$435,900 - \$1,273,900	\$666	\$683	30.4
<p>1. Construction Status: "Pre" = pre construction, "UC" = under construction. 2. Average dollar per square foot: original value is based on total inventory at the time of the project launch, current value is based on remaining inventory. 3. Average sales per month (absorption rate): the top number represents the number of sales per month, the bottom number represents the number of months. 70% rate is calculated from the project opening date until at least 70% sold, overall rate is calculated from the project opening date to the current date (December 31, 2018).</p> <p>Source: Altus Group / RealNet</p>												

Map 3: Location of Projects on the Dundas Street Corridor

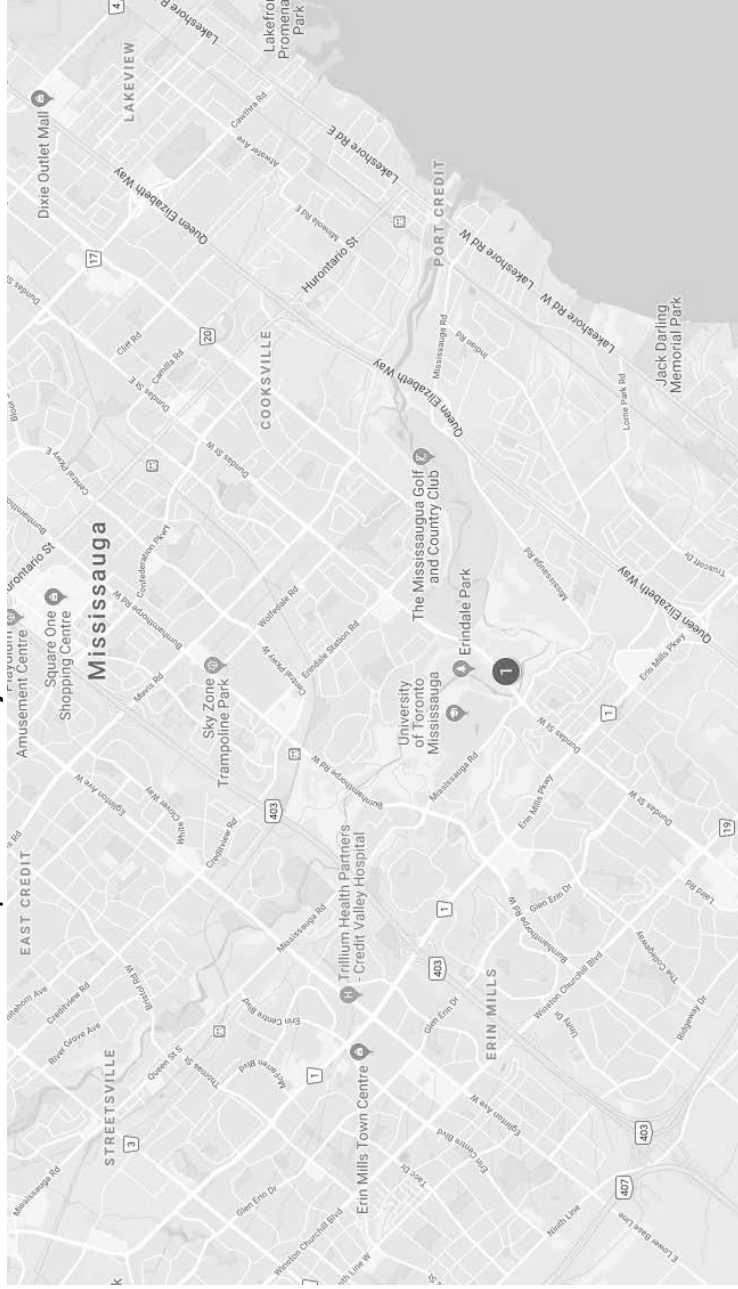

Surveyed Actively Marketing (New) Stacked Townhouse Projects in the City of Mississauga

As of December 31, 2018

Map ID	Project Name / Developer	Open Date	Con. Status ¹	Storeys	Total Units Released	Total Sales	% Sold	Size Range (sf)	Price Range	Avg. \$PSF ²		Avg. Sales/Mo. ³	
										Orig.	Curr.	70%	Overall
1	Stride Kingsmen Group Inc.	Dec-18	Pre	4	164	52	0%	823 - 1,567	\$573,900 - \$1,033,900	\$670	\$670	-	0.0
2	Eleven11 Clarkson Saxon Developments	Nov-18	Pre	4	136	56	28%	710 - 1,687	\$512,900 - \$1,070,900	\$640	\$639	-	22.7
3	Way Urban Towns in Erin Mills Sorbara	Mar-18	UC	4	144	144	83%	988 - 1,339	\$620,900 - \$731,900	\$525	\$581	29.8	12.5
4	Reserve East Mineola Queenscorp Group	Apr-17	UC	3	146	146	68%	940 - 1,896	\$629,900 - \$975,900	\$519	\$597	-	4.9
5	Summit Collection at Summit City Centre Summit View Homes	Apr-17	Pre	3	54	54	81%	1,060 - 1,305	\$559,990 - \$624,990	\$479	\$501	16.0	2.4
Total / Average / Range: 5 Projects				4	644	452	47%	710 - 1,896	\$512,900 - \$1,070,900	\$548	\$640	24.0	5.7

1. Construction Status: "Pre" = pre construction, "UC" = under construction. 2. Average dollar per square foot: original value is based on total inventory at the time of the project launch, current value is based on remaining inventory. 3. Average sales per month (absorption rate); the top number represents the number of sales per month, the bottom number represents the number of months. 70% rate is calculated from the project opening date until at least 70% sold, overall rate is calculated from the project opening date to the current date (December 31, 2018).

Source: Altus Group / RealNet

Map 4: Location of Stacked Townhomes in Mississauga



Recently Sold Out Condominium Apartment Projects in Bolton													
As of December 31, 2018													
Map ID	Project Name / Developer	Open Date	Con. Status ¹	Stores	Total Units Released	Total Sales	% Sold	Size Range (sf)	Price Range	Avg. \$PSF ²		Avg. Sales/Mo. ³	
										Org.	Curr.	70%	Overall
1	River's Edge Armour Heights Developments	Oct-07	SI	5	67	67	100%	785 - 1,325	\$299,990 - \$471,990	\$360	\$367	2.1	1.7
Total / Average / Range: 1 Projects				5	67	67	100%	785 - 1,325	\$299,990 - \$471,990	\$360	\$367	2.1	1.7

1. Construction Status: "pre" = pre construction, "UC" = under construction. 2. Average dollar per square foot: original value is based on total inventory at the time of the project launch, current value is based on remaining inventory. 3. Average sales per month (absorption rate): the top number represents the number of sales per month, the bottom number represents the number of months. 70% rate is calculated from the project opening date until at least 70% sold, overall rate is calculated from the project opening date to the current date (December 31, 2018).

Source: Altus Group / RealNet

Map 5: Location of Projects in Bolton

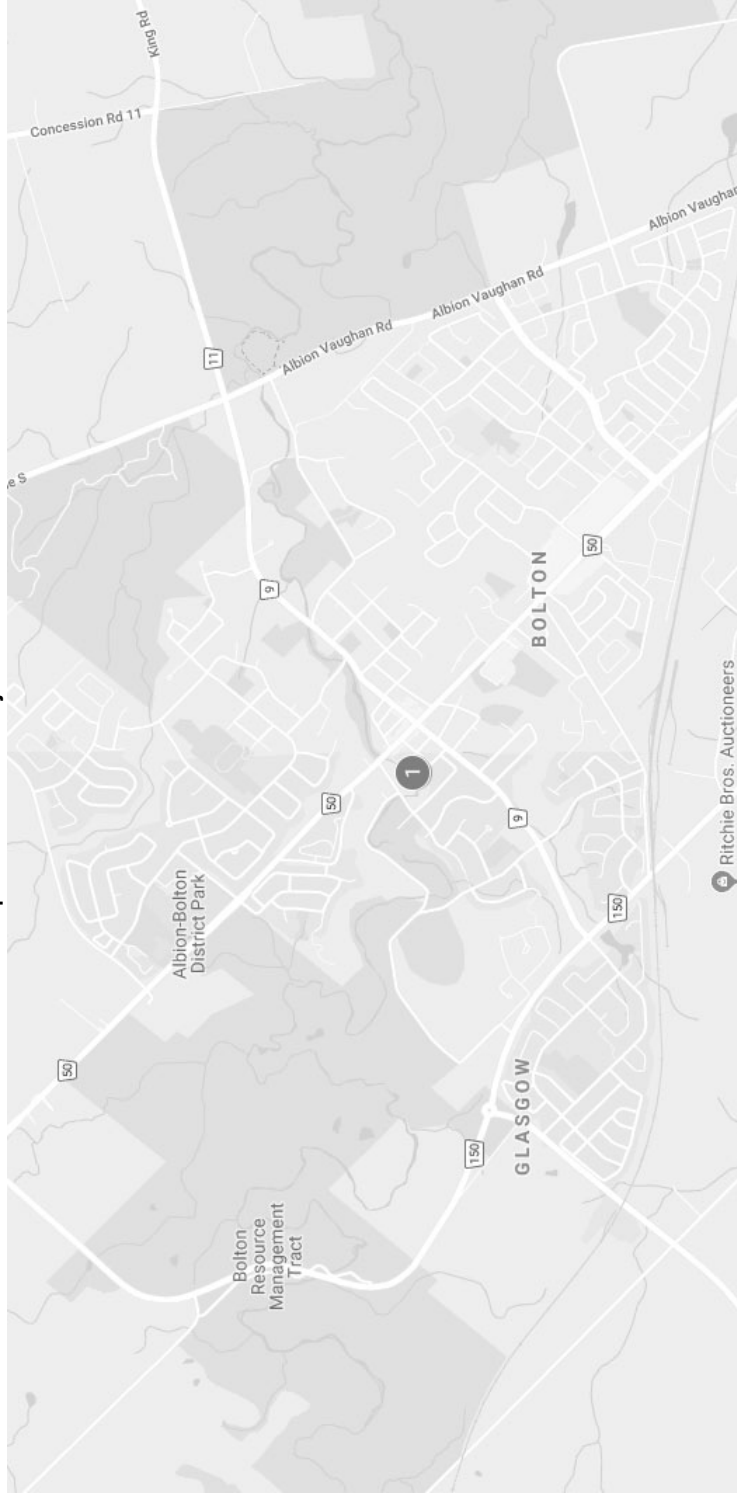

Surveyed Actively Marketing (New) Single-Detached Homes in Caledon As of December 31, 2018													
Map ID	Project Name / Developer	Open Date	Product Type	Tenure	Lot Size (ft)	Lot Type	# Units	# Sold	% Sold	Size Range (sf)	Price Range	Avg. \$/PSF ¹	Avg. Sales / Mo. ²
1	Pathways Caledon East CountryWide Homes & Brookfield Residential	Apr-18	Detached	Freehold	50	Traditional	17	13	76%	3,056 - 4,164	\$1,289,990 - \$1,464,990	\$387	1.6
		Oct-17	Detached	Freehold	46	Traditional	20	2	10%	2,840 - 3,480	\$1,129,990 - \$1,229,990	\$379	0.1
		Jun-17	Detached	Freehold	46	Traditional	30	11	37%	2,504 - 3,880	\$1,119,990 - \$1,329,990	\$390	1.2
		May-17	Detached	Freehold	38	Traditional	26	24	92%	2,270 - 3,090	\$959,990 - \$1,104,990	\$390	1.2
		May-17	Detached	Freehold	42	Traditional	24	22	92%	2,890 - 2,890	\$1,174,990 - \$1,174,990	\$407	1.1
		Nov-10	Detached	Freehold	50	Traditional	165	161	98%	3,090 - 3,770	\$1,199,990 - \$1,279,990	\$366	2.9
		Apr-18	Detached	Freehold	43	Traditional	33	28	85%	3,196 - 3,589	\$1,099,900 - \$1,137,900	\$330	3.4
2	Starlane Home Corporation	Sep-14	Detached	Freehold	38	Traditional	164	155	95%	2,504 - 3,171	\$969,900 - \$1,099,900	\$351	5.5
		Oct-17	Detached	Freehold	30	Wide Shallow	8	0	0%	2,502 - 2,721	\$1,006,900 - \$1,096,900	\$404	0.0
3	Humberstone Marycraft Homes	May-17	Detached	Freehold	189	Traditional	33	13	39%	2,259 - 7,119	\$1,615,000 - \$3,200,000	\$522	0.7
		May-17	Detached	Freehold	205	Rear Lane	9	7	78%	2,259 - 6,619	\$1,615,000 - \$3,010,000	\$558	0.4
4	Mount Pleasant Preserve Dunsire Developments	Apr-17	Detached	Freehold	220.5	Traditional	12	10	83%	3,876 - 4,441	\$1,979,000 - \$2,130,000	\$496	0.5
		Apr-17	Detached	Freehold	36	Traditional	68	43	63%	2,290 - 2,950	\$949,900 - \$1,199,900	\$415	2.5
5	Village of Southfield Coscorp Inc.	Sep-08	Detached	Freehold	36	Traditional	627	622	99%	2,450 - 2,869	\$957,000 - \$976,000	\$360	6.6
Totals / Ranges / Averages: 7 Projects (14 Product Offerings)							1,236	1,111	90%	2,259 - 7,119	\$949,900 - \$3,200,000	\$414	3.2

1. Average dollar per square foot is based on available inventory. 2. Average sales per month is calculated from the project opening date to the current date, subtracting months when no inventory was on the market.

Source: Altus Group / Real Net

Map 5: Location of Projects in Bolton

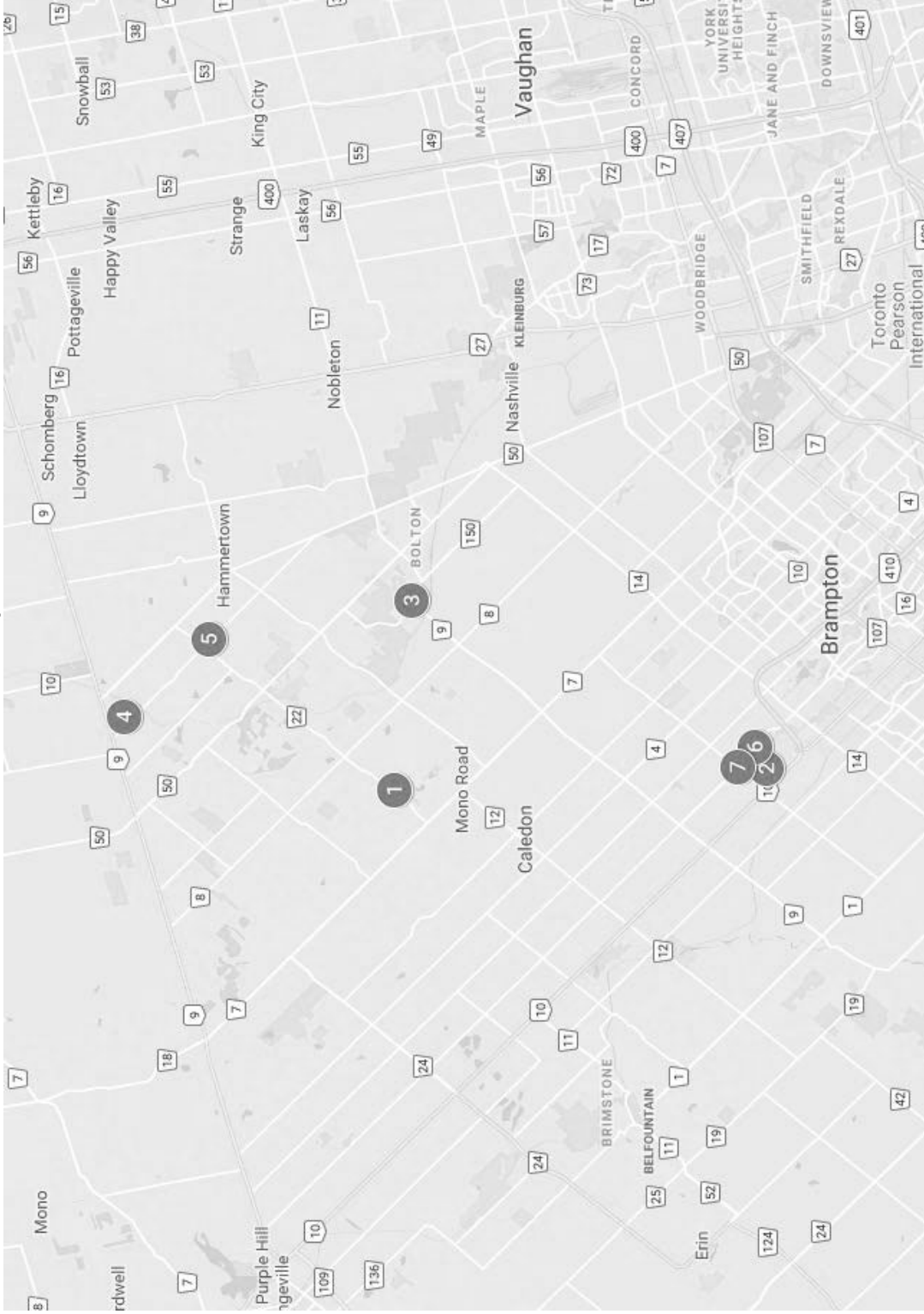

Appendix C: Land Transaction Data

HighDensity Residential Land Transactions in Mississauga January 1, 2014 to December 31, 2018										
Base Transaction Information					Staff Report/Approval Information					
Map ID	Address	Transaction Date	Purchaser	Transaction Price	Land Area (Ac.)	Price per Acre	No. Proposed Units	Price per Unit	Proposed GFA (SF)	\$PSF Buildable
1	3154 Hurontario Street	Nov-18	TAS DesignBuild	\$14,000,000	0.89	\$11,266,865	-	-	-	-
	25 Hillcrest Avenue	Jul-18		\$10,500,000	1.28	-	-	-	-	-
2	22 Ann Street	Nov-18	Edenshaw Developments Ltd.	\$2,300,000	0.13	\$13,856,041	-	-	-	-
	28 Ann Street	Oct-18		\$1,640,000	0.13	-	-	-	-	-
	78 Park Street East	May-18		\$1,450,000	0.14	-	-	-	-	-
3	619 Lakeshore Road East	Jun-18	Breda Group	\$4,125,000	0.41	\$9,963,768	-	-	-	-
4	1381 Lakeshore Road East	Jun-18	City Park Homes	\$5,465,000	1.04	\$5,249,760	-	-	-	-
5	3324 Mississauga Road	May-18	The Governing Council of The University of Toronto	\$2,160,000	2.03	\$1,851,079	-	-	-	-
	3300 Mississauga Road	Apr-18		\$1,640,000	0.40	-	-	-	-	-
	3284 Mississauga Road	Apr-18		\$1,520,000	0.44	-	-	-	-	-
6	800 Hydro Road (Lakeview Lands)	Mar-18	Lakeview Community Partners Limited	\$274,770,000	176.68	\$1,555,167	8,000	\$34,346	-	-
7	21 Queen Street North	Dec-17	Lamb Development Corp	\$5,200,000	2.40	\$2,166,667	430	\$12,093	336,624	\$15
8	425 Lakeshore Road East	Nov-17	Indwell Community Homes	\$2,650,000	0.54	\$4,907,407	66	-	-	-
	29 Park Street East	Oct-17		\$6,000,000	0.25	-	-	-	-	-
9	27 Park Street East	Aug-17	Edenshaw Park Developments Limited	\$1,105,800	0.07	\$15,302,372	207	\$56,109	206,839	\$56
	25 Park Street East	Aug-17		\$1,658,700	0.18	-	-	-	-	-
	21 Park Street East	Aug-17		\$2,850,000	0.25	-	-	-	-	-
10	1345 Lakeshore Road East	Sep-17	VANDYK Group of Companies	\$16,000,000	3.13	\$5,111,821	397	\$40,302	383,798	\$42
11	3518, 3528 & 3536 Hurontario Street & 24, 34, 38, 44, 50, 58, & 64 Elm Drive West	Sep-17	Solmar Development Corp.	\$34,200,000	3.59	\$9,521,158	1,367	\$25,018	1,457,411	\$23
12	501 Lakeshore Road East	Aug-17	Senator Homes	\$12,500,000	6.54	\$1,912,777	296	\$42,230	-	-
13	90 High Street East	Jun-17	Real-T-Masters Inc.	\$3,100,000	0.54	\$5,794,393	-	-	-	-
14	70 Mississauga Road South	Mar-17	Port Credit West Village Partners Inc.	\$175,000,000	72.76	\$2,405,035	2,969	\$58,942	4,095,959	\$43

15	152 & 180 Burnhamthorpe Road West and 3672 Kariya Drive	Mar-17	Bene Development (Ontario) Ltd.	\$35,000,000	5.91	\$5,925,174	416	\$84,135	366,497	\$95
16	4064 - 4070 Dixie Road	May-16	Hazelton Development Corporation	\$3,950,000	0.95	\$4,217,736	261	\$22,414	181,544	\$32
		4078 Dixie Road	May-16		\$1,900,000					
17	3480 Hurontario Street	Feb-16	The Conservatory Group	\$5,250,000	0.58	\$9,098,787	360	\$14,583	303,590	\$17
18	6 Ann Street	Jan-15	Fram Building Group	\$2,260,000	0.19	\$9,102,296	71	\$61,408	88,532	\$49
	8 Ann Street	Jan-15		\$1,200,000	0.17					
	10 Ann Street	Dec-12		\$900,000	0.12					
	3 Benson Avenue	Jun-14		\$1,025,000	0.10					
	7 Benson Avenue	Jun-14		\$1,025,000	0.14					
	266 Lakeshore Road West	Jul-13		\$2,300,000	0.37					
	5 Benson Avenue	Jul-13		\$1,210,000	0.14					
	139 High Street West	Jul-13		\$653,625	0.14					
	125 High Street West	Jul-13		\$650,000	0.17					
	131 High Street West	Jul-13		\$735,000	0.23					
	135 High Street West	Jul-13		\$810,000	0.21					
	143 High Street West	Jun-13		\$950,000	0.14					
	127 High Street West	Jun-13		\$862,500	0.23					
	280 Lakeshore Road West	Jun-13		\$1,200,000	0.33					
141 High Street West	Sep-12	\$580,000	0.14							
290 Lakeshore Road West	Sep-12	\$778,000	0.21							
274 Lakeshore Road West	Mar-12	\$1,100,000	0.34							
20	71 - 79 Agnes Street	Jan-14	Matas Homes	\$3,500,000	0.70	\$4,985,755	-	-	-	-
Total/Average (20 Transactions):				\$647,673,625	285.76	\$2,266,467	15,165	\$39,144	7,690,977	\$40

Source: RealNet Canada Inc.; Urbanation Marsh Report; City of Mississauga Planning Department; NBLC

Medium Density Residential Land Transactions in Mississauga January 1, 2014 to December 31, 2018												
Base Transaction Information				Transaction Information					Staff Report/Approval Information			
Map ID	Address	Transaction Date	Purchaser	Transaction Price	Land Area (Ac.)	Price per Acre	No. Proposed Units	Price per Unit	Proposed GFA (SF)	\$PSF Buildable		
1	Ninth Line & Roadside Way	Oct-18	Mattamy Homes	\$8,375,000	7.02	\$1,192,850	-	-	-	-		
2	2225 Erin Mills Parkway (Sheridan Centre)	May-18	Dunpar Homes	\$70,000,000	29.95	\$2,337,541	-	-	-	-		
3	1575 Hurontario Street	Apr-18	Dream Maker Developments Inc.	\$6,750,000	0.97	\$6,958,763	60	\$112,500	301,389	\$22		
4	Ninth Line & Roadside Way	Mar-18	Argo Land Development	\$6,120,000	7.02	\$871,671	-	-	-	-		
5	1041 Lakeshore Road East	Sep-17	Fortress Real Developments	\$11,950,000	0.81	\$14,753,086	73	\$163,699	-	-		
6	208 Emby Drive 51 Tannery Street 57 Tannery Street	Jun-17 Jun-17 Apr-17	NYX Capital Corp.	\$5,540,000 \$2,200,000 \$3,500,000	3.14 0.76 0.71	\$2,438,707	155	\$72,516	-	-		
7	611 Derry Road West	May-17	Realux Mississauga Inc.	\$5,500,000	1.76	\$3,125,000	30	\$183,333	-	-		
8	4005 Hickory Drive	Apr-17	Sierra Building Group	\$4,830,000	1.97	\$2,451,777	102	\$47,353	109,588	\$44		
9	189 Dundas Street West	Feb-17	Solotex Corporation	\$12,100,000	3.48	\$3,477,011	224	\$54,018	-	-		
10	3016-3032 Kirwin Avenue & 3031 Littlejohn Lane	Sep-16	2531388 Ontario Inc.	\$1,850,000	1.59	\$1,162,060	64	\$28,906	-	-		
11	1198 Cawthra Road 1206 Cawthra Road 1174, 1178, 1184, 1188 & 1192 Cawthra Road	Jun-16 May-16 Jun-14	Queenscorp Residences	\$1,250,000 \$1,100,000 \$4,125,000	0.48 0.47 2.37	\$1,951,477	146	\$44,349	211,403	\$31		
12	2200 Bromsgrove Road	Jun-16	Haven Developments	\$3,250,000	1.25	\$2,595,847	74	\$43,919	54,368	\$60		
13	1115 Clarkson Road North 1109 Clarkson Road North 1105 Clarkson Road North 1101 Clarkson Road North	Feb-16 May-15 Jul-14 May-13	Continental Saxon Group	\$3,300,000 \$625,000 \$1,999,000 \$2,425,000	0.49 0.10 0.29 1.59	\$3,370,610	216	\$38,653	163,906	\$51		
14	2277 South Millway	Jan-16	The Sorbara Group	\$6,000,000	3.01	\$1,994,018	144	\$41,667	186,216	\$32		
15	3355 The Collegeway	Dec-15	The Sorbara Group	\$15,610,000	6.57	\$2,376,675	364	\$42,885	441,320	\$35		
16	3111 Cawthra Road 3123 Cawthra Road	Aug-15 Aug-15	Maple Valley Development Corporation Inc.	\$1,300,000 \$2,000,000	0.55 0.96	\$2,176,781	42	\$78,571	48,321	\$68		
17	650 Atwater Avenue	Apr-15	Sierra Building Group	\$4,275,000	1.77	\$2,412,528	110	\$38,864	-	-		
				Total/Average (17 Transactions):	79.09	\$2,351,393	1,804	\$56,252	1,516,512	\$36		

Source: RealNet Canada Inc.; Urbanation Marsh Report; City of Mississauga Planning Department; NBLC

Low Density Residential Land Transactions in Caledon January 1, 2017 to December 31, 2018											
Base Transaction Information			Staff Report/Approval Information								
Map ID	Address	Transaction Date	Purchaser	Transaction Price	Land Area (Ac.)	Price per Acre	No. Proposed Units	Price per Unit	Proposed GFA (SF)	\$PSF Buildable	
1	n/e corner of Heart Lake Road & Mayfield Road	Dec-18	Coscorp Inc. (Coscorp HL Developments Inc.)	\$11,000,000	15.74	\$698,768	-	-	-	-	-
2	8410 Mayfield Road	Dec-18	Boltcool Holdings South Inc.	\$4,060,799	6.58	\$617,143	-	-	-	-	-
3	12168 & 12280 Humber Station Road	Nov-18	Solmar Development Corp. (Venture Holding Corp.)	\$9,315,000	119.73	\$77,803	-	-	-	-	-
4	Side Road No. 5 & Highway 50 9023 Sideroad 5	Oct-18	Treasure Hill Homes (Villalago Residences Inc.)	\$1,464,020	0.05	\$1,645,360	-	-	-	-	-
		Mar-16		\$10,083,053	6.97		-	-	-	-	-
5	17346 Centreville Creek Road	Aug-18	Lockton Estate Farm Ltd.	\$2,100,000	96.39	\$21,786	-	-	-	-	-
6	12156 Chinguacousy Road	Jul-18	Argo Development Corporation (Argo Mayfield West III Limited)	\$4,300,000	14.71	\$292,338	-	-	-	-	-
7	8282 Mayfield Road	Jun-18	2635922 Ontario Inc.	\$2,750,000	4.88	\$563,525	-	-	-	-	-
8	12529 Chinguacousy Road	Jun-18	FP Mayfield West (Caledon) Inc.	\$8,000,000	103.47	\$77,317	-	-	-	-	-
9	Troilless Street & Travelled Road	Jun-18	Hira Homes (Hira Custom Homes Inc.)	\$1,220,000	3.23	\$377,358	-	-	-	-	-
10	12191 Centreville Creek Road	May-18	An individual(s) acting in his/her own capacity	\$2,500,000	10.00	\$250,000	-	-	-	-	-
11	s/w corner of Kennedy Road & Dougall Avenue	Mar-18	Genesis Homes (Buttermilk Developments Inc.)	\$11,000,000	6.53	\$1,685,565	-	-	-	-	-
12	12728 Kennedy Road	Dec-17	Greenpark Homes (Yeoman Developments Inc.)	\$1,071,000	not listed		-	-	-	-	-
13	12782 Kennedy Road	Nov-17	Coscorp Inc. (Brentwood Development Corporation)	\$5,062,000	3.69	\$1,372,357	66	\$76,697	cannot find GFA	?	
14	8040 Mayfield Road	Oct-17	Townwood Homes (Participant Investors Inc.)	\$1,500,000	1.64	\$912,409	-	-	-	-	-
15	15505 Airport Road 15717 Airport Road	Oct-17	DG Group (Triple Crown Line Developments Inc.)	\$6,830,194	9.51	\$656,900	562	\$184,840	cannot find GFA	?	
		Oct-16		\$97,050,000	148.62		-	-	-	-	-
16	1 & 2 Russel Mason Court & 6122, 6126 & 6142 Old Church Road	Oct-17	Stylux Caledon Inc.	\$4,660,000	2.99	\$1,559,572	-	-	-	-	-
17	12944 Albion Vaughan Road	Jul-17	Mosaik Homes (Queensgate (Mosaik) Inc.)	\$3,950,000	2.43	\$1,625,514	-	-	-	-	-
18	12306 Chinguacousy Road	Jul-17	Argo Land Development (Argo Mayfield West II Limited)	\$20,000,000	99.50	\$201,003	-	-	-	-	-

19	Coleraine Drive & Mayfield Road	Jun-17	Solimar Development Corp. (Equity Inc.)	\$4,414,500	9.82	\$449,359	-	-	-
20	Mississauga Road & Shaws Creek Road	Jun-17	The Manors of Belfountain Corp.	\$5,800,000	226.28	\$25,632			
21	12519 Humber Station Road	Apr-17	Solimar Development Corp. & Royal Pine Homes	\$44,262,000	99.30	\$445,731			
22	Humber Station Road	Apr-17	Ballantry Homes	\$40,120,200	49.26	\$741,007	-	-	-
	Humber Station Road	Apr-17		\$32,951,200	49.35				
23	12461 McLaughlin Road	Mar-17	The Conservatory Group (Shanontown Developments Inc.)	\$92,500,000	145.00	\$637,944	677	\$136,632	cannot find GFA
	550 Glasgow Road	Mar-17		\$3,125,000	5.05				
24	615 Glasgow Road	Feb-17	Zancor Homes (Zancor Homes (Bolton) Ltd.)	\$1,725,000	6.78	\$1,401,071	-	-	-
	13977 Chickadee Lane	Feb-17		\$2,350,000	1.04				
	13999 Chickadee Lane	Feb-17		\$1,425,000	0.75				
	600 Glasgow Road	Feb-17		\$1,425,000	0.98				
	13935 - 13951 Chickadee Lane	Jan-17		\$24,740,000	10.24				
25	6600 Old Church Road & 16133 Innis Lake Road	Mar-17	Country Wide Homes & Brookfield Residential (Caledon 1) Inc.	\$101,600,000	71.44	\$1,422,153	321	\$316,511	cannot find GFA
26	12456 Heritage Road	Feb-17	Primont Homes (Primont (Caledon 1) Inc.)	\$18,934,729	105.47	\$179,532	-	-	-
27	Amelia Street & Queen Street West	Feb-17	Mount Nicholas Holdings Inc.	\$1,450,000	14.64	\$99,030	-	-	-
28	12729 Torbram Road	Feb-17	Pemberton Group (Sentinel (Torbram) Holdings Inc.)	\$20,007,976	150.51	\$132,368	-	-	-
	Torbram Road	Feb-17		\$9,992,024	76.13				
29	12515 Mississauga Road	Jan-17	2536630 Ontario Inc.	\$6,000,000	49.90	\$120,245	-	-	-

Source: RealNet Canada Inc.; Urbanation Marsh Report; Town of Caledon Planning Department; NBLC

High Density Residential Land Transactions in Caledon

January 1, 2014 to December 31, 2018

Base Transaction Information			Staff Report/Approval Information							
Map ID	Address	Transaction Date	Purchaser	Transaction Price	Land Area (Ac.)	Price per Acre	No. Proposed Units	Price per Unit	Proposed GFA (SF)	\$PSF Buildable
1	50 Ann Street	Dec-15	Brookfield Homes (Brookfield Homes (Ontario) Limited)	\$1,700,000	0.89	\$1,901,566	72	\$23,611.11		

Source: RealNet Canada Inc.; Urbanation Marsh Report; Town of Caledon Planning Department; NBLC

Appendix D: Home Value and Development Charge Data

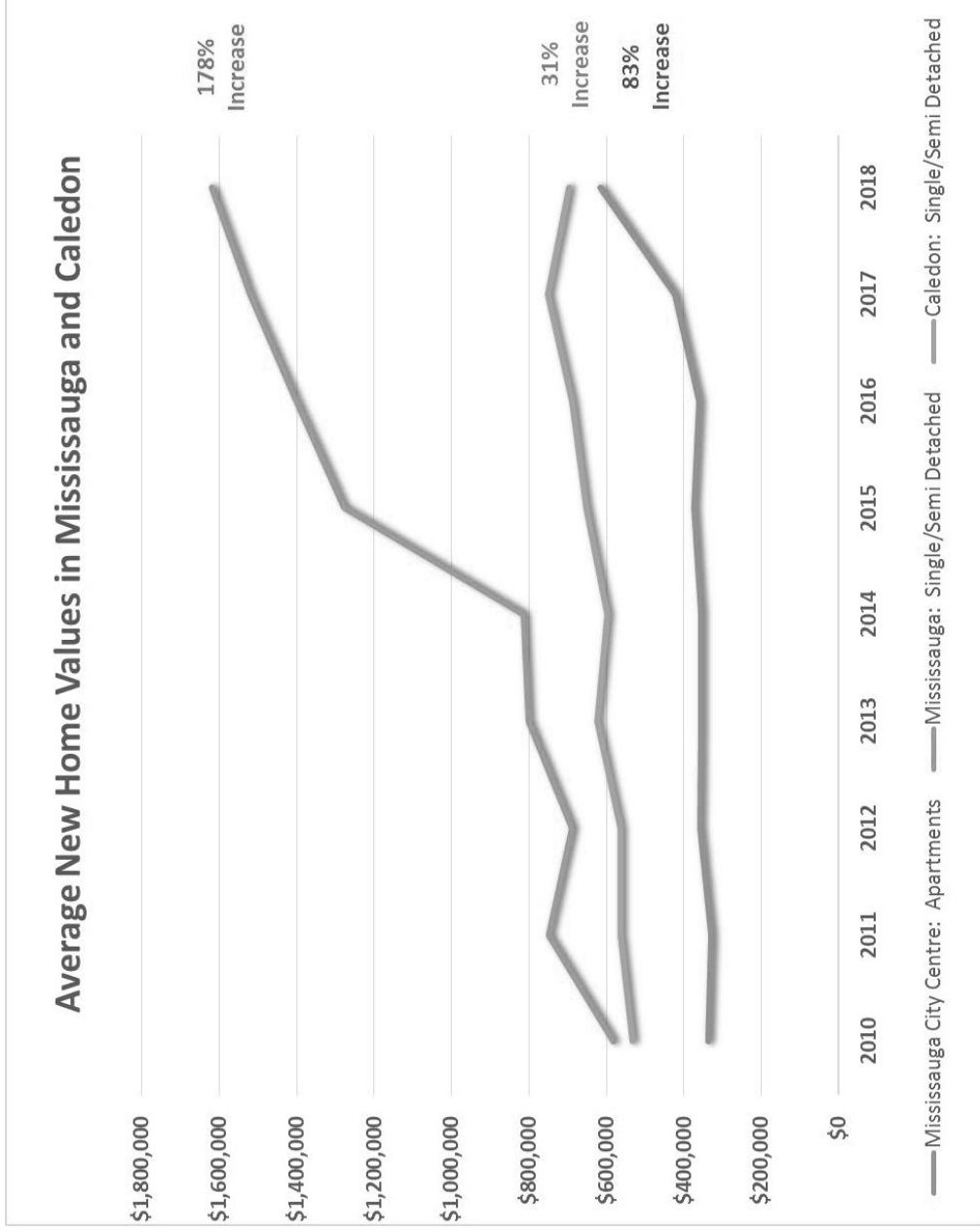

Source: Altus New Homes High Rise Submarket Report Mississauga City Centre (February Reports 2010-2018) and CMHC Housing Portal Data

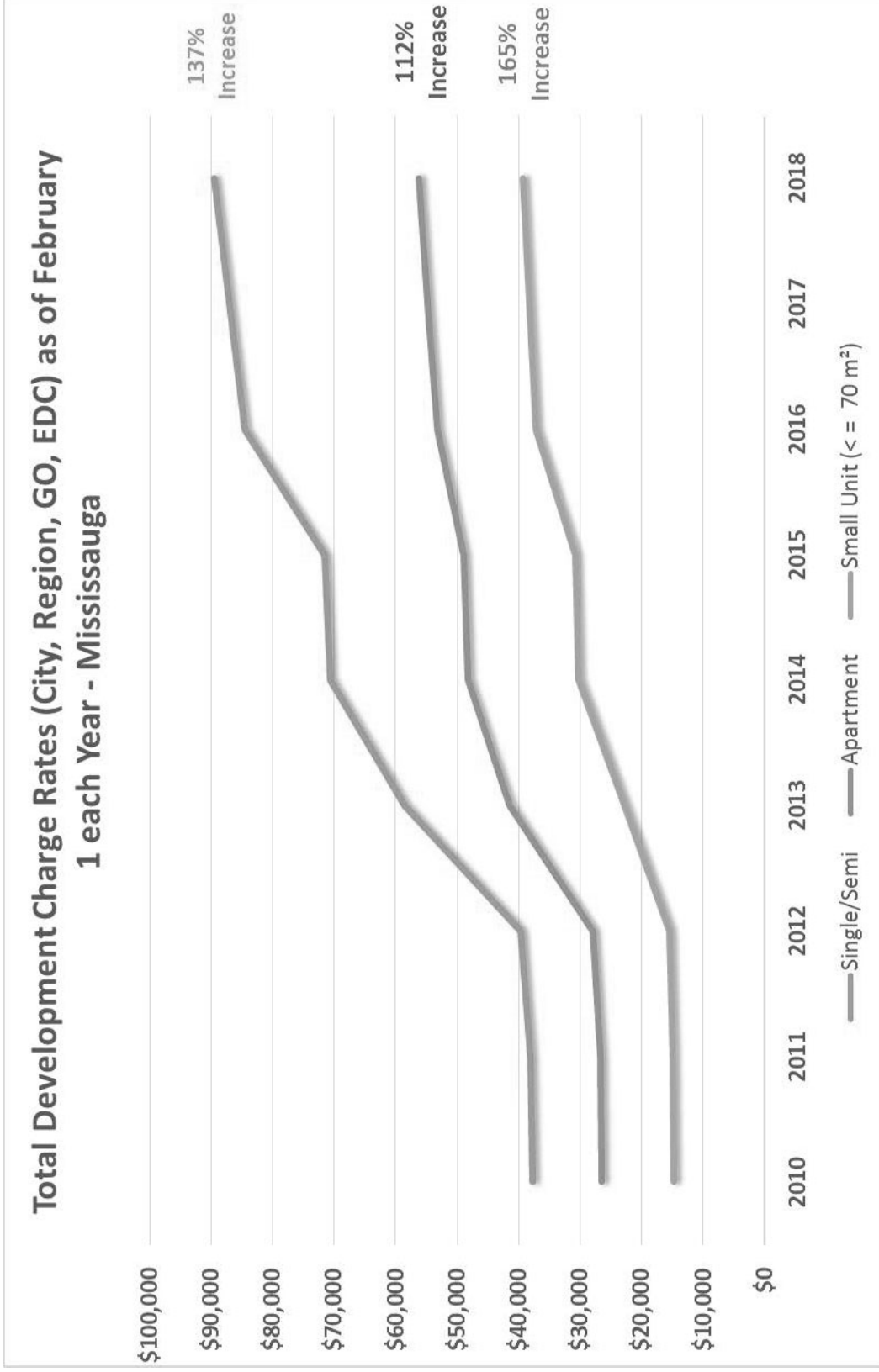

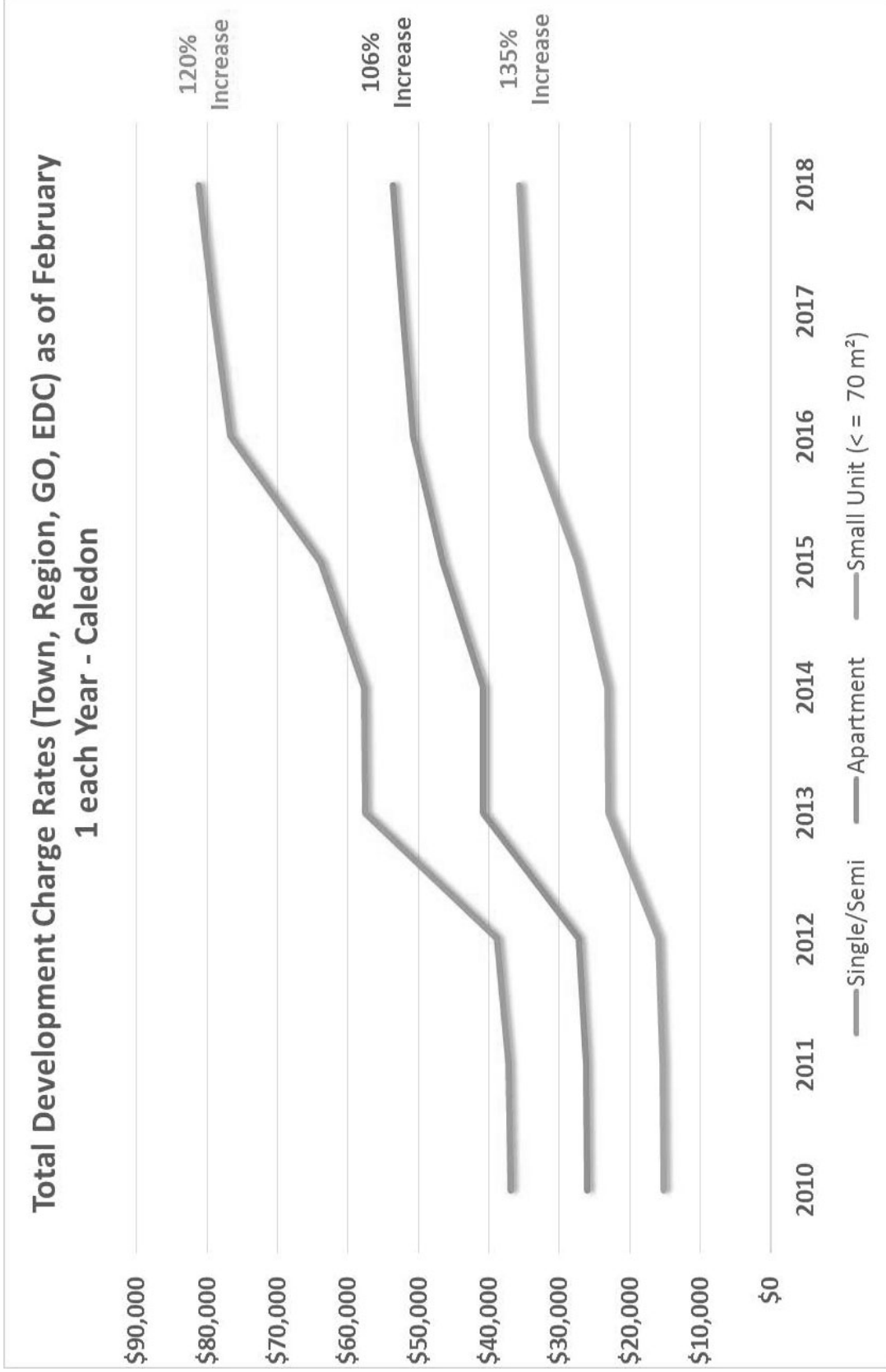

Source: City of Mississauga and Town of Caledon (For Mississauga Stormwater Management Charge Calculation: Assume 100 units per 0.5 hectare for apartments/small units and 25 units per hectare for single/semi-detached homes for Mississauga's Stormwater Charge. Small unit in Mississauga is below 65 m², Region of Peel is 70 m².)